

Chroma signal frequency converter

BA7049S/BA7049FS

The BA7049S and BA7049FS convert NTSC, PAL-M and PAL-N chroma signal subcarrier frequencies to the PAL format 4.433619MHz to allow PAL format processing circuits to handle record and playback signals for these other formats. These ICs facilitate the development of multi-format VCRs.

●Applications

Multi-format VHS VCRs.

●Features

- 1) Converts record and playback signals to standard format.
- 2) Compatible with up to three other formats in addition to PAL.
- 3) Y and chroma system filters switches are all built-in. Few external components required.

●Block diagram

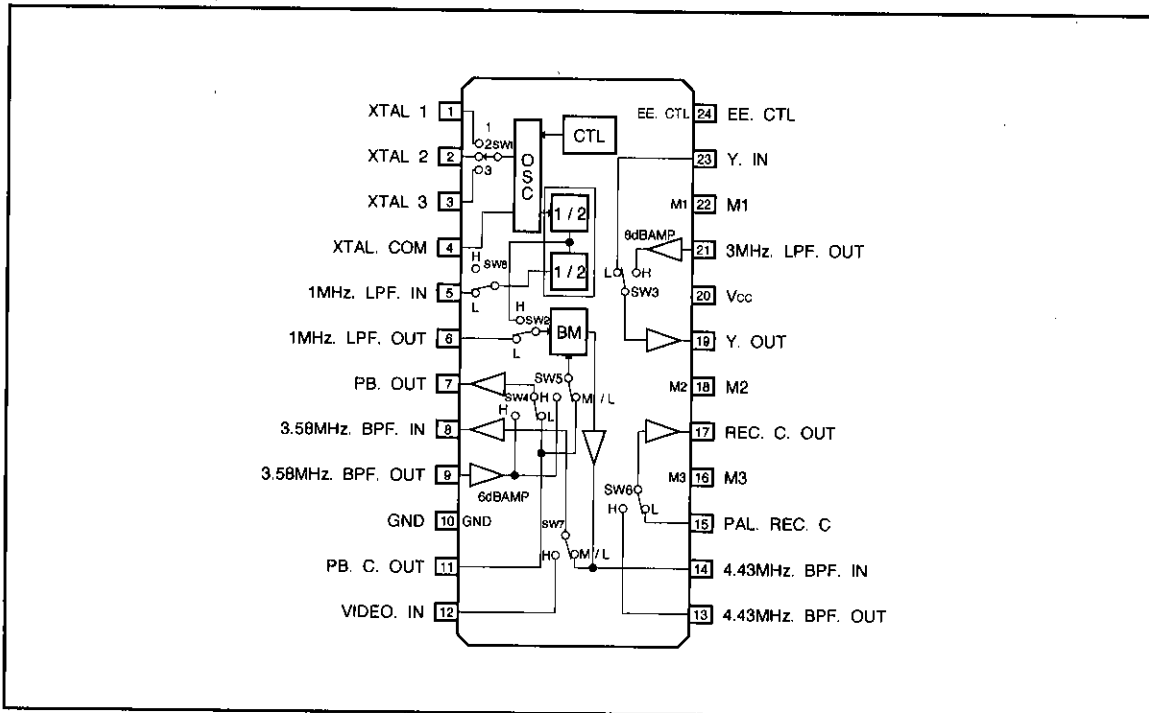

● Absolute maximum ratings (Ta=25°C)

Parameter	Symbol	Limits	Unit
Applied voltage	V _{CC Max.}	8.0	V
Power dissipation	P _d	800 *	mW
Operating temperature	T _{opr}	-25~70	°C
Storage temperature	T _{stg}	-55~125	°C

* Reduced by 8.0mW for each increase in Ta of 1°C over 25°C.

● Recommended operating conditions (Ta=25°C)

Parameter	Symbol	Min.	Typ.	Max.	Unit
Operating supply voltage	V _{CC}	4.5	5.0	5.5	V

● Electrical characteristics (Unless otherwise specified: Ta=25°C and V_{CC}=5.0V)

Parameter	Symbol	Min.	Typ.	Max.	Unit	Conditions
Circuit current	I _{CC}	20.5	31.0	41.5	mA	
0dB amplifier voltage gain	G ₀	-0.5	0.0	+0.5	dB	f=1MHz Vin=0.5V _{PP}
0dB amplifier frequency characteristic	f ₀	-2.0	+0.0	+1.0	dB	f=5MHz / 1MHz Vin=0.5V _{PP}
6dB amplifier voltage gain	G ₆	+5.5	+6.0	+6.5	dB	f=1MHz Vin=0.25V _{PP}
6dB amplifier frequency characteristic	f ₆	-2.0	+0.0	+1.0	dB	f=5MHz / 1MHz Vin=0.25V _{PP}
Interchannel crosstalk	C _T	-	-45	-40	dB	f=4.43MHz Vin=0.5V _{PP}
Frequency divider output level	V _{OE}	0.50	0.85	1.30	V _{PP}	When 3.4MHz/3.58MHz X'tal is oscillating
BM output level	V _{OB}	125	185	245	mV _{PP}	f=3.58MHz Vin=0.3V _{PP}
BM carrier leak	CL _B	-	-40	-30	dB	f=3.58MHz Vin=0.3V _{PP}
Switch voltage 1	V _{TH1}	1.00	2.00	3.00	V	M1, M2, M3
Switch voltage 2	V _{TH2}	3.50	3.90	4.35	V	EE, CTL

● Guaranteed design items (Unless otherwise specified: Ta=25°C and V_{CC}=5.0V)

Parameter	Symbol	Min.	Typ.	Max.	Unit	Conditions
0dB amplifier voltage gain	G ₀	-1.0	0.0	+0.5	dB	f=4MHz Vin=0.5V _{PP}

© Not designed for radiation resistance.

NTSC/PAL format converters

VCR components

●Logic truth table

M1	M2	SW1
L	L	—
H	L	1
L	H	2
H	H	3

M1	M2	SW3, 4, 6
L	L	L
H	L	H
L	H	H
H	H	H

M1	M2	SW8
L	L	H
H	L	L
L	H	L
H	H	L

M3	SW2
L	L
H	H

EE. CTL	SW5, 7
H	H
M/L	M/L

●Input / output circuits

Pin No.	Function	Pin voltage		Input/output resistance	Equivalent circuit
		DC	AC		
1	XTAL 1	2.0V	1.0V _{PP}	150Ω	
2	XTAL 2	2.0V	1.0V _{PP}	150Ω	

Pin No.	Function	Pin voltage		Input/output resistance	Equivalent circuit
		DC	AC		
3	XTAL 3	2.0V	1.0V _{PP}	150 Ω	
4	XTAL.COM	2.0V	1.7V _{PP}	5kΩ	
5	LPF. IN (1MHz)	4.0V	850mV _{PP}	130 Ω	
6	LPF. OUT (1MH)	2.0V	500mV _{PP}	20kΩ	
7	PB. OUT	2.0V	300mV _{PP}	130 Ω	

NTSC/PAL format converters

VCR components

Pin No.	Function	Pin voltage		Input/output resistance	Equivalent circuit
		DC	AC		
8	BPF. IN (3.58MHz)	2.3V	1.0V _{PP}	150Ω	
9	BPF. OUT (3.58MHz)	2.0V	150mV _{PP}	20kΩ	
10	GND	0V	—	—	
11	PB. C. OUT	2.0V	300mV _{PP}	20kΩ	
12	VIDEO. IN	2.0V	300mV _{PP}	20kΩ	

Pin No.	Function	Pin voltage		Input/output resistance	Equivalent circuit
		DC	AC		
13	BPF. OUT (4.43MHz)	2.0V	150mV _{PP}	20k Ω	
14	BPF. IN (4.43MHz)	2.2V	1.0V _{PP}	130 Ω	
15	PAL. REC. C	2.0V	150mV _{PP}	20k Ω	
16	M3	60mV	—	50k Ω	
17	REC. C. OUT	2.0V	150mV _{PP}	130 Ω	

NTSC/PAL format converters

VCR components

Pin No.	Function	Pin voltage		Input/output resistance	Equivalent circuit
		DC	AC		
18	M2	60mV	—	50kΩ	
19	Y. OUT	2.0V	400mV _{PP}	130Ω	
20	VCC	5.0V	—	—	
21	LPF. OUT (3MHz)	2.0V	200mV _{PP}	20kΩ	
22	M1	60mV	—	50kΩ	

Pin No.	Function	Pin voltage		Input/output resistance	Equivalent circuit
		DC	AC		
23	Y. IN	2.0V	400mV _{PP}	20kΩ	
24	EE. CTL	0.5V	—	2MΩ or more	

● Circuit operation

Recording

A balance modulator is used to convert the subcarrier frequency of the input chroma signal to PAL-format subcarrier frequency.

The local oscillator used for frequency conversion uses a x'tal to generate a frequency of four times the required frequency. This frequency is divided-by-four internally using a frequency divider.

Signals converted to the PAL-format subcarrier frequency by this IC are input to a chroma processing IC equipped with a PAL filter. By operating the circuit in NTSC mode for NTSC signals and in PAL mode for PAL-M and PAL-N signals, a low-frequency output signal in the converted format is obtained.

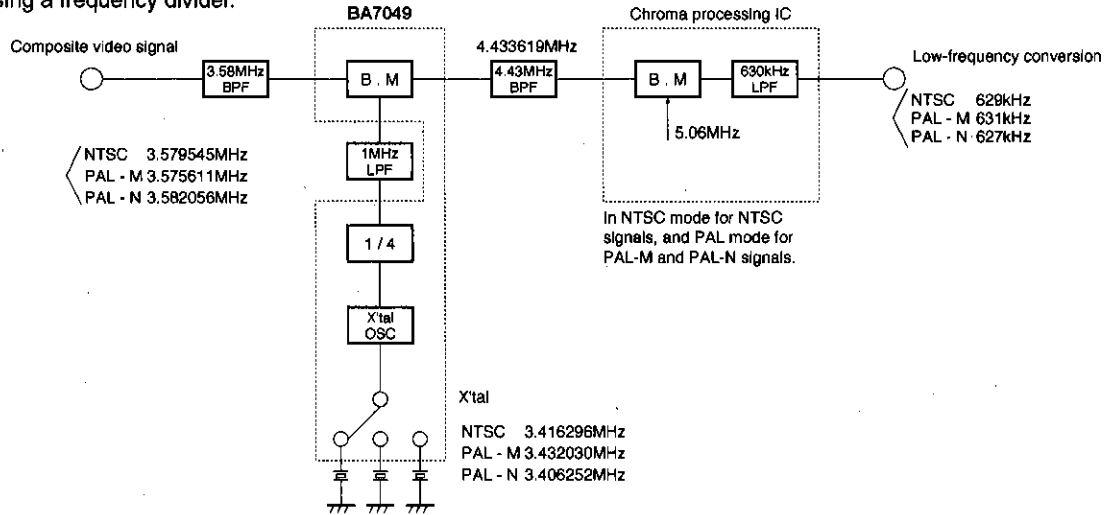

Fig.1

●Circuit operation

Playback

During playback, an NTSC or PAL signal with a subcarrier frequency of 4.433619MHz is output. Using the opposite procedure to that of recording, these signals are con

verted to NTSC, PAL-M, or PAL-N subcarrier-frequency signals.

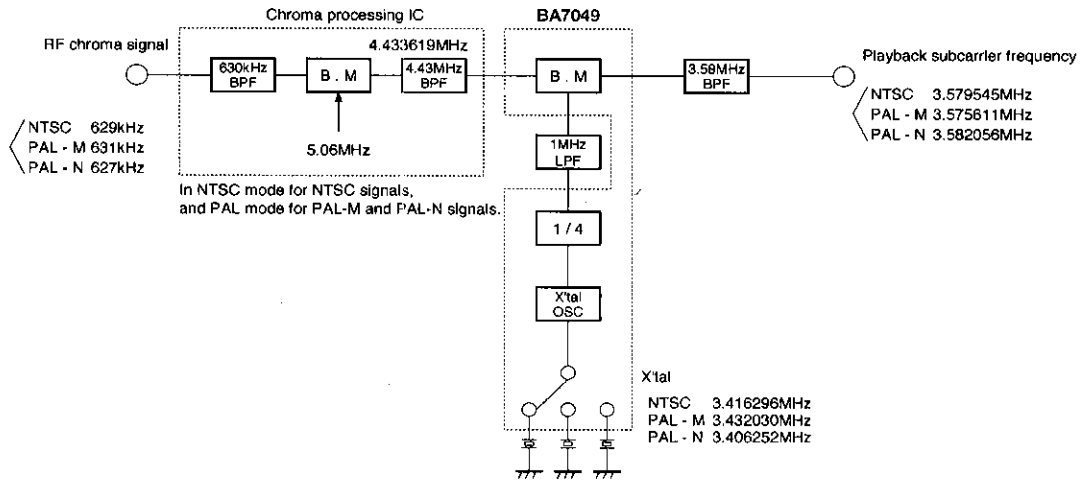

Fig.2

●Application example

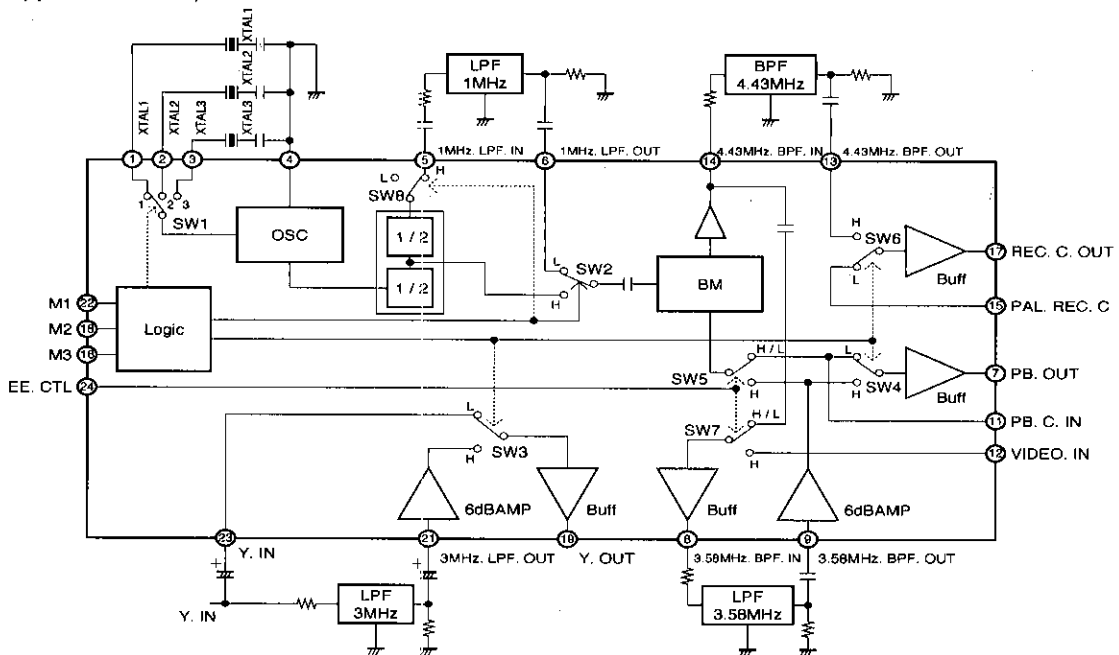

Fig.3

●Operation notes

External components for the x'tal oscillator
 The external circuit for the oscillator is shown below. The capacitor values are for reference only. Determine suitable values for the capacitors after consulting with the crystal manufacturer.

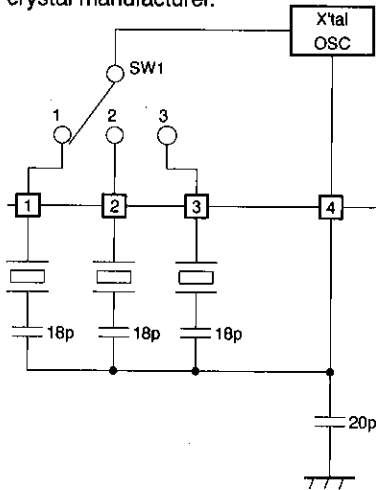

Fig. 4

●Electrical characteristic curves (Ta=25°C)

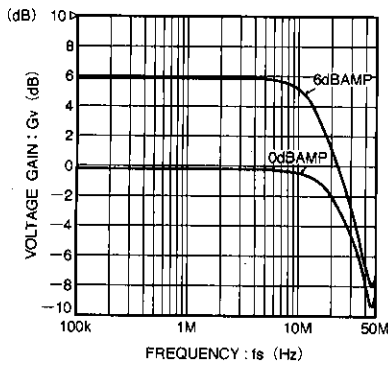

Fig. 5 SW frequency characteristics

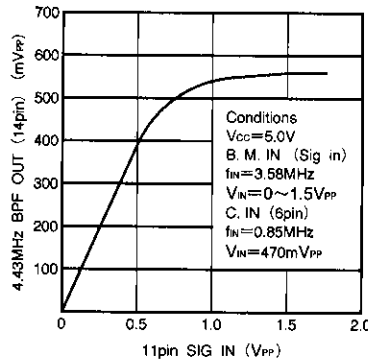

Fig. 6 B.M.D. range characteristics

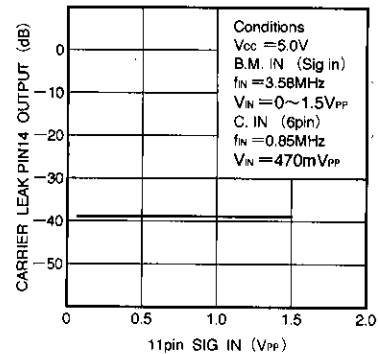

Fig. 7 B.M. carrier leak characteristics

- 6dB AMP
- 9pin in → 7pin out
- 21pin in → 19pin out
- 0dB AMP
- 11pin in → 7pin out
- 12pin in → 8pin out
- 13pin in → 17pin out
- 15pin in → 17pin out
- 23pin in → 19pin out

NTSC/PAL format converters

VCR components

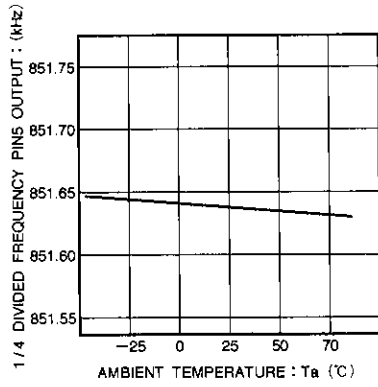

Fig. 8 1/4 frequency divider frequency vs. ambient temperature characteristics.

● External dimensions (Units: mm)

