

NTSC-to-PAL format converter

BA7045/BA7045FS

The BA7045 and BA7045FS are NTSC-to-PAL converter ICs. They include a sub-carrier frequency doubler circuit, balance modulator, half-H killer circuit, phase comparator circuit, voltage controlled oscillator circuit, burst-gate pulse generator circuit, 1/2 frequency divider, circuit 3dB and 12dB amplifiers circuit, and two switch circuits. The ICs convert NTSC chroma signals recovered from a 4.43MHz sub-carrier into PAL chroma signals. They can also convert 3.58MHz NTSC chroma signals into M-PAL chroma signals. In addition, by using external control to switch the internal analog switches, jumping compensation for PAL VTR EP mode is possible.

●Applications

Video cassette recorders

●Features

- 1) Low power dissipation.
- 2) Converts 4.43MHz NTSC to PAL.
- 3) Jumping compensation for PAL VTR EP mode.
- 4) Few external components required.
- 5) Adjustable balance modulator (BM) gain.
- 6) Adjustable burst gate pulse phase.
- 7) Compatible with M-PAL.

●Block diagram

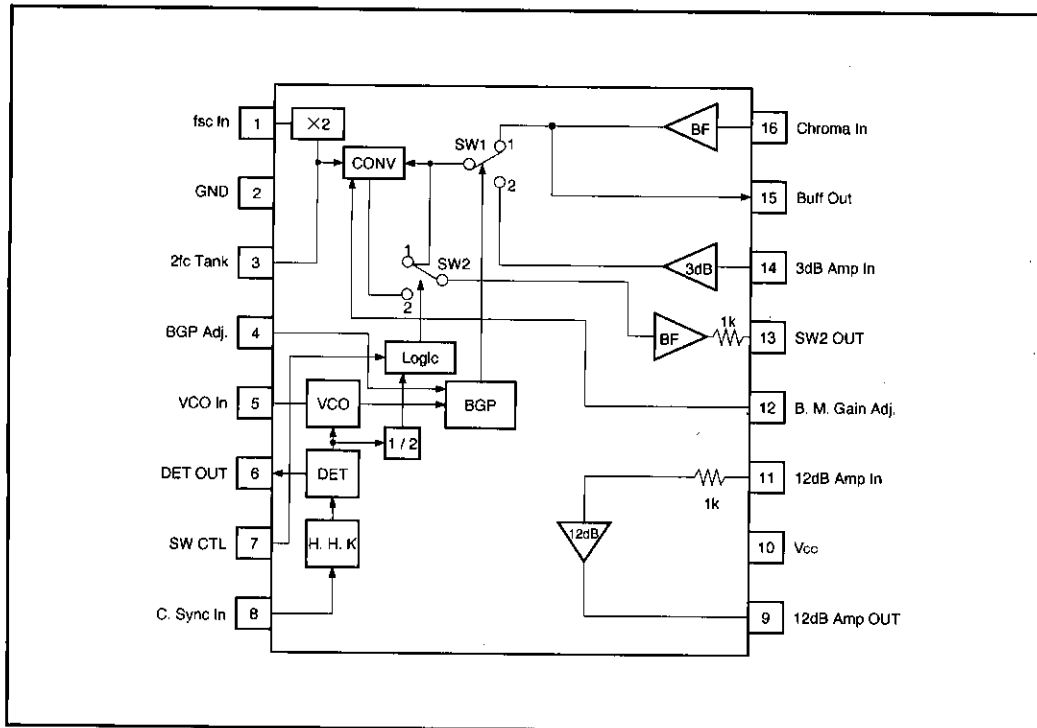

● Pin descriptions

Pin No.	Pin name	Function
1	fsc In	Sub-carrier input
2	GND	GND
3	2fc Tank	For connection to frequency-doubling tank circuit.
4	BGP Adj.	Burst gate pulse position adjustment
5	VCO In.	VCO control input
6	DET Out	Phase difference detector output
7	SW CTL	Internal analog switch control
8	C. Sync In	C. Sync input
9	12dB Amp OUT	12dB amplifier output
10	Vcc	Power supply
11	12dB Amp In	12dB amplifier input
12	B. M. Gain Adj.	Balance modulator gain adjustment
13	SW2 Out	SW2 output
14	3dB Amp In	-45° chroma signal input
15	Buff Out	For connection to low-pass filter
16	Chroma In	4.43MHz chroma signal input

● Input / output circuits

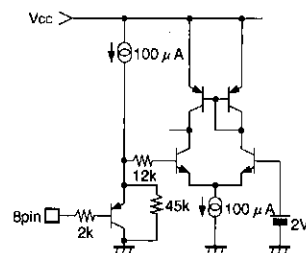
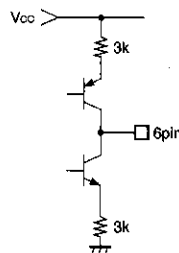
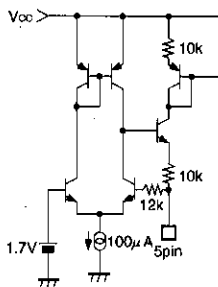
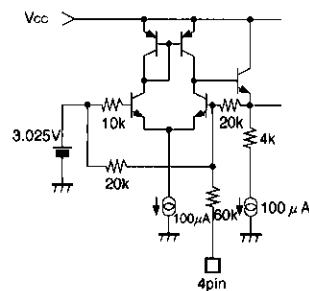
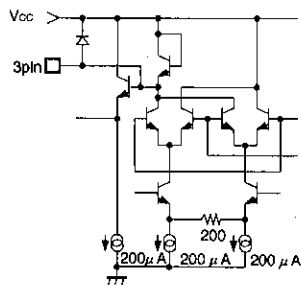
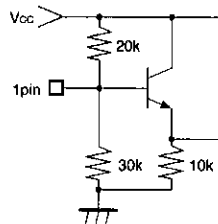

VCR components



NTSC/PAL format converters

● Input / output circuits

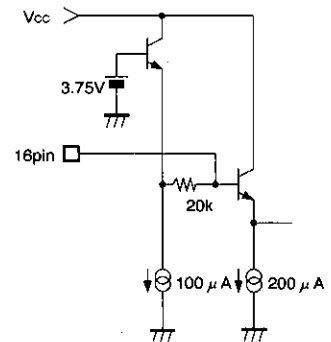
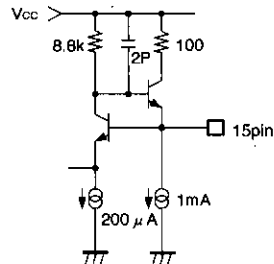
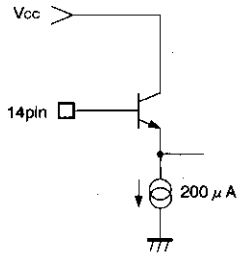
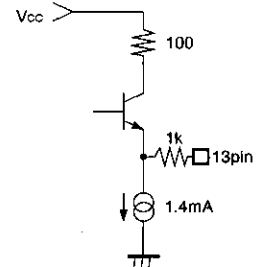
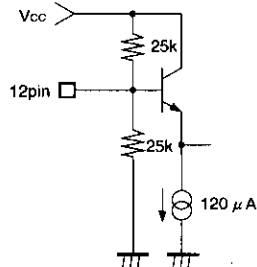
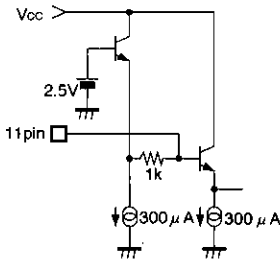
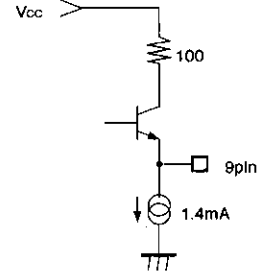
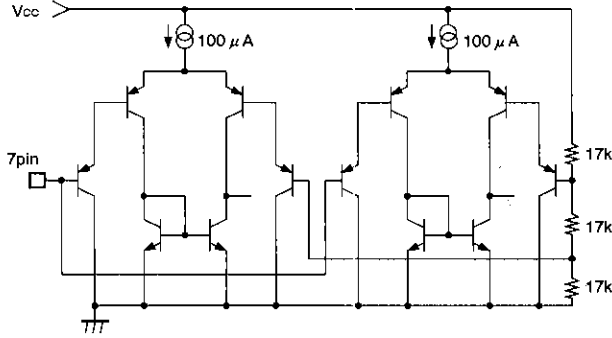

● Absolute maximum ratings (Ta=25°C)

Parameter	Symbol	Limits	Unit
Applied voltage	V _{CC Max}	8.0	V
Power dissipation	P _d	1100	mW
Operating temperature	T _{opr}	-25~70	°C
Storage temperature	T _{stg}	-55~125	°C

* Reduced by 11.0mW for each increase in Ta of 1°C over 25°C.

● Recommended operating conditions (Ta=25°C)

Parameter	Symbol	Limits	Unit
Supply voltage	V _{CC}	4.5~5.5	V

● Electrical characteristics (Unless otherwise specified Ta=25°C and V_{CC}=5.0V)

Parameter	Symbol	Min.	Typ.	Max.	Unit	Conditions
Quiescent current	I _{CC}	—	24.0	36.0	mA	
Pin 13 DC level difference	ΔV _{O13}	—	0	50.0	mV	ΔV _{C13} = CONV - NonCONV
Pin 16 to pin 11 gain	G ₁₆₋₁₁	-7.8	-6.8	-5.8	dB	f=4.43MHz, V _{IN16} =300mVpp
Pin 16 to pin 9 gain	G ₁₆₋₉	5.2	6.2	7.2	dB	f=4.43MHz, V _{IN16} =300mVpp
Pin 14 to pin 11 gain	G ₁₄₋₁₁	-6.7	-5.7	-4.7	dB	f=4.43MHz, V _{IN14} =300mVpp
B.M. gain O	B _g - O	-1.0	0	1.0	dB	f=4.43MHz, V _{IN16} =300mVpp
B.M. gain L	B _g - L	2.0	3.5	5.0	dB	f=4.43MHz, V _{IN1} =500mVpp
B.M. gain H	B _g - H	-4.0	-2.5	-1.0	dB	B _g =CONV _{Gain} - NonCONV _{Gain} Adjustable via pin 12
Free-running frequency	f _{FREE}	13.9	15.7	17.5	kHz	No signal on pin 8
AFC lock confirm	f _{LO}	—	15.734	—	kHz	
BGP width	T _B	6.0	7.0	8.5	μsec	
BGP phase O	PhB - O	8.0	10.0	12.0	μsec	
BGP phase L	PhB - L	16.0	21.0	26.0	μsec	Adjustable via pin 4
BGP phase H	PhB - H	-4.9	0.1	5.1	μsec	
HHK operation confirmation 1	HHK1	—	15.7	—	kHz	
HHK operation confirmation 2	HHK2	—	15.7	—	kHz	
Pin 8 switching level H	V _{TH8} - H	2.1	—	5.0	V	
Pin 8 switching level L	V _{TH8} - L	0	—	0.5	V	
SW switching voltage H	CTL - H	3.7	4.1	4.5	V	
SW switching voltage M	CTL - M	2.1	2.5	2.9	V	
SW switching voltage L	CTL - L	0.5	0.9	1.3	V	

○ Not designed for radiation resistant.

● Guaranteed design items (Unless otherwise specified: Ta=25°C and V_{CC}=5.0V)

Parameter	Symbol	Min.	Typ.	Max.	Unit	Conditions
Dynamic range of 12dB amplifier	D ₁₁₋₉	2.0	2.5	—	V	f=1kHz, THD=5%
Capture range	Δf _{cap}	±2.0	±2.5	—	kHz	
B.M. carrier leak	C _{Leak}	—	-32	—	dB	f=4.43MHz, V _{IN16} =300mVpp f=4.43MHz, V _{IN1} =500mVpp

●Circuit operation

This IC is used to convert NTSC-format video tape recordings to PAL format for playback on PAL-format VCRs. The IC converts an NTSC chroma signal recovered from a 4.43MHz sub-carrier to a PAL chroma signal. With the PAL system, a color burst signal is repeated every 1H at phases of $+45^\circ$ and -45° with respect to the E_B -Y axis. Therefore, to convert NTSC to PAL, the color burst signal at each 1H is shifted by $+45^\circ$ or -45° rela-

tive to the E_B -Y axis. The color signal that is shifted by -45° is used as is, but in the case of the color signal that is shifted by $+45^\circ$, the reflection of this signal across the E_B -Y axis is used.

With the BA7045, the signal processing indicated above is performed at each block. Also, the NTSC signal can be converted to a regular PAL signal.

BA7045 timing chart

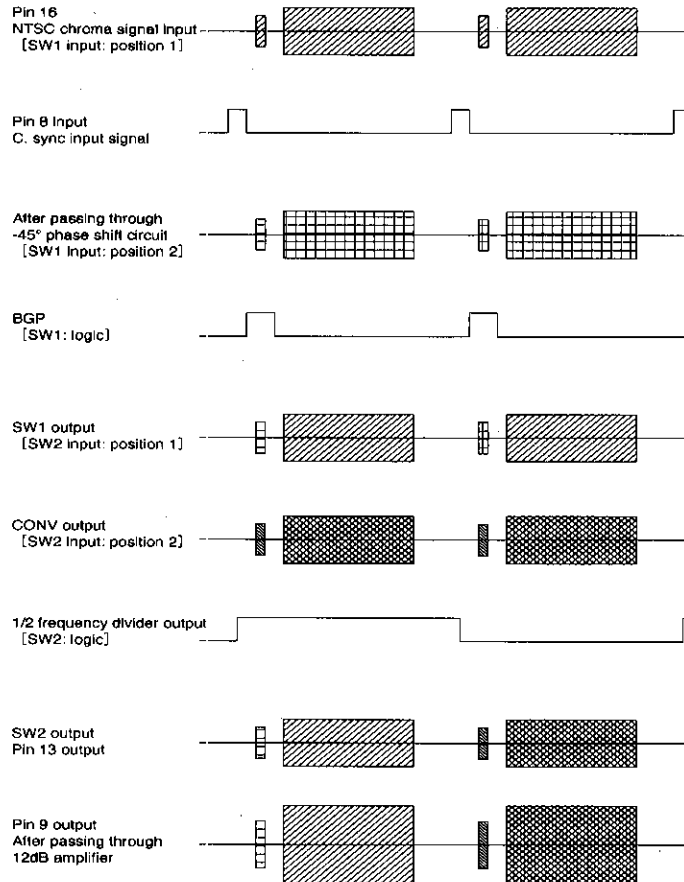

Fig.1 Timing chart

●Control logic

SW CTL	SW1 position	SW2 position
High	1	1
Middle	1	2
Low	Auto	Auto

●Application example

NTSC to PAL signal conversion (NTSC→PAL)

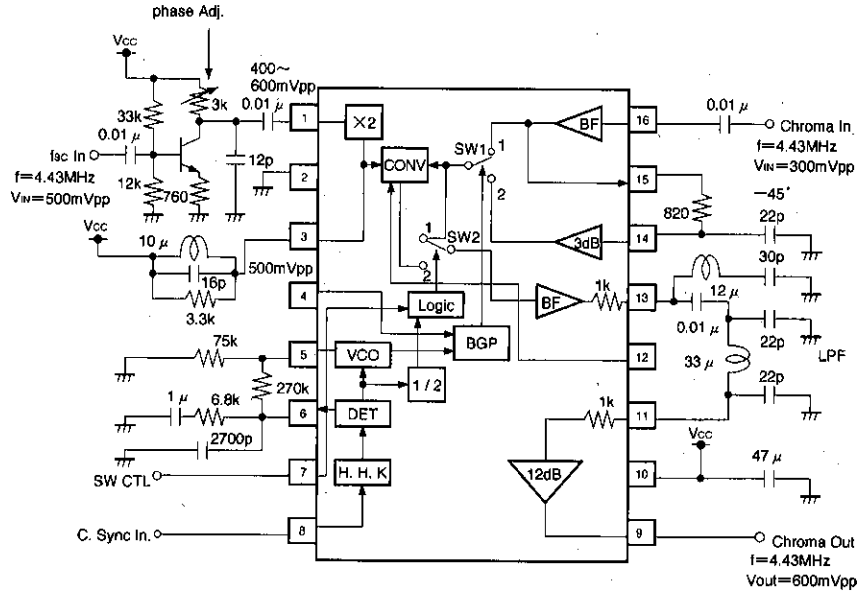

Fig. 2 NTSC to PAL conversion

NTSC to M-PAL signal conversion (NTSC→M-PAL)

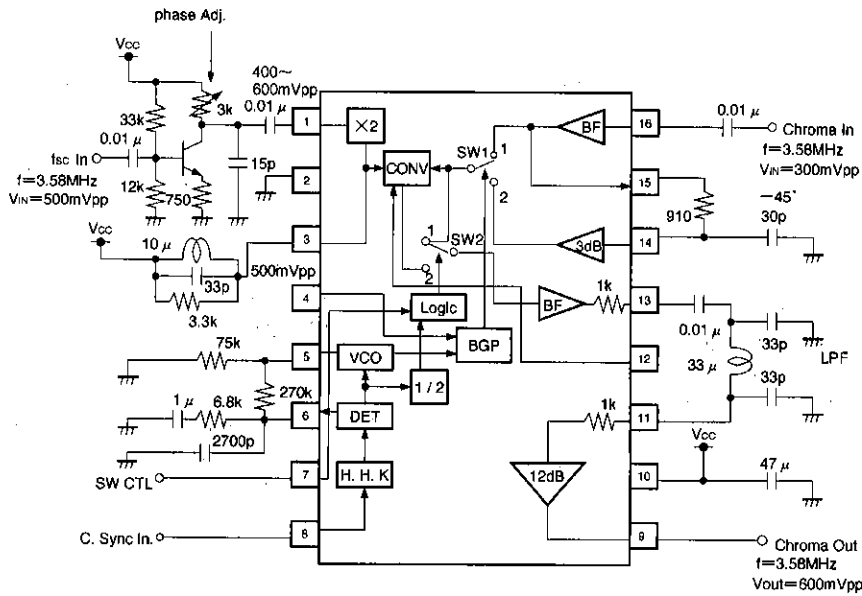

Fig. 3 NTSC to M-PAL conversion

NTSC/PAL format converters

VCR components

● Operation notes

1. VCO free-running frequency and capture range
The free-running frequency of the VCO set by the 75 Ω resistor connected between pin 5 and GND. This resistor should have a tolerance of $\pm 2\%$ and a temperature coefficient of 100ppm or less. The capture range of the circuit is set by the values of the resistors and capacitor connected between pins 5 and 6.

The free-run frequency and capture range of the circuit are guaranteed for these component values, and we recommend that you use them.

2. Adjustment of the pin 3 tank circuit

Adjust the frequency f_0 of the tank circuit connected to pin 3 to 8.86MHz. If fixed-value components are used, adjustment is not necessary, but if you are using variable components and wish to adjust f_0 , do not connect the measuring instrument (frequency counter or oscilloscope) directly to pin three, as this will cause the frequency to change. Connect the measuring instrument via a transistor buffer circuit as shown in Fig. 4. Select the value of the Q damping resistor R so that the voltage on pin 3 is between 500mV_{P-P} and 600mV_{P-P}.

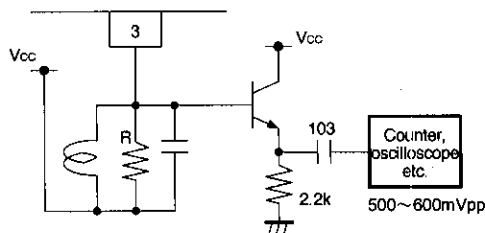

Fig. 4 Tank circuit

3. Adjustment of the color phase

The IC modulates the input signal by $-\text{COS}2\omega_{ST}$ to generate a waveform that is symmetric about the E_B -Y axis. To generate this waveform, adjust the phase of the sub-carrier signal on pin 1. To adjust the phase of the sub-carrier signal, observe the signal burst angle using a vectorscope, and adjust the phase angle of the pin 1 sub-carrier signal to 90° .

4. Use in M-PAL systems

When using the IC in M-PAL systems (chroma sub-carrier 3.57561149MHz) use the following circuit constants:

1. Change the f_0 frequency of the tank circuit connected to pin 3 to 7.15MHz.
2. Change the values of the phase circuit components between pins 14 and 15 to 910 Ω and 30pF.
3. Change the low-pass filter connected between pins 11 and 13 to ensure sufficient attenuation at 10MHz (3fsc).

5. Screen beat

If screen beat occurs, employ the following countermeasures:

Generation mechanism

Screen beat is caused by spectral components other than the 4.43MHz signal included in the chroma signal input to pin 16.

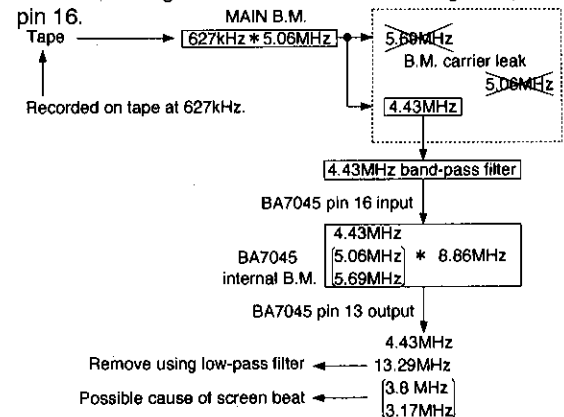

Countermeasures

- (1) Ensure sufficient attenuation for spectral components other than 4.43MHz in the BM output (5.06MHz and 5.69MHz) that is the pin 16 chroma signal input.
- (2) Change the low-pass filter connected between pins 11 and 13 to a 4.43MHz band-pass filter to eliminate the effect of the 3.17MHz and 3.8MHz frequency components. When carrying out these countermeasures, use a spectrum analyzer to monitor the frequency spectrum at each pin.

●External dimensions (Units: mm)

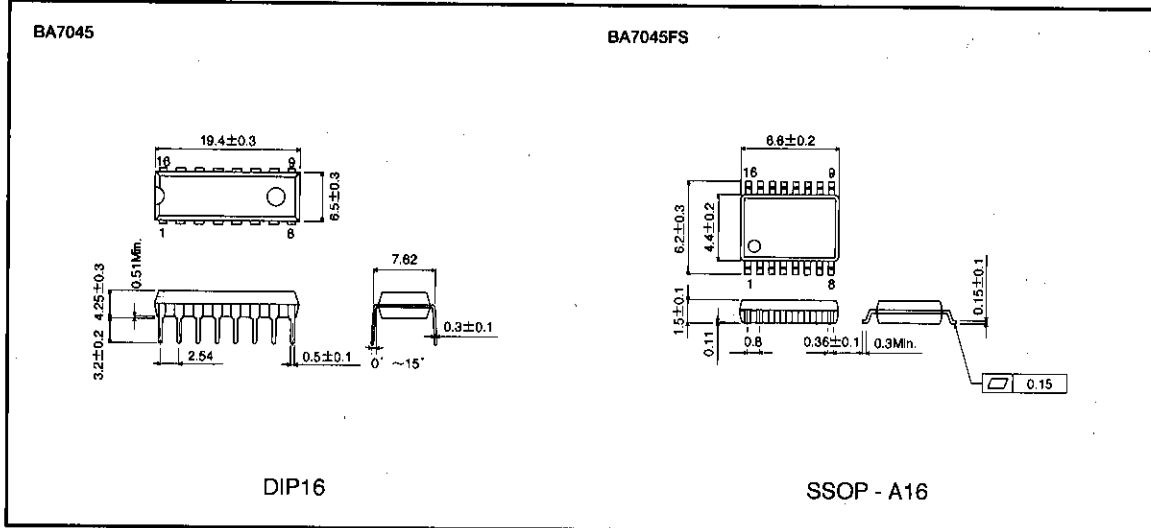

VCR components NTSC/PAL format converters