

# LED level meter driver, 5-point, linear scale

## BA6125

The BA6125 is a driver IC for LED VU level meters in stereo equipment and other display applications.

The IC displays the input level on five LEDs. The display level range is  $35\text{mV}_{\text{rms}}$  to  $175\text{mV}_{\text{rms}}$  in five equally-spaced  $35\text{mV}_{\text{rms}}$  steps.

The BA6125 includes a rectifier amplifier allowing direct AC input, and has constant-current outputs, so it can directly drive the LEDs without variations in LED current due to supply voltage fluctuations.

### ● Applications

Parity checkers, signal meters, and other display devices.

### ● Features

- 1) Rectifier amplifier allows either AC or DC input.
- 2) Constant-current outputs for constant LED current when the supply voltage fluctuates.
- 3) Built-in reference voltage means that power supply voltage fluctuations do not effect the display.
- 4) Wide operating voltage range (3.5V to 16V) for a wide range of applications.
- 5) Low PCB space requirements. Comes in a compact 9-pin SIP package and requires few external components.

### ● Block diagram

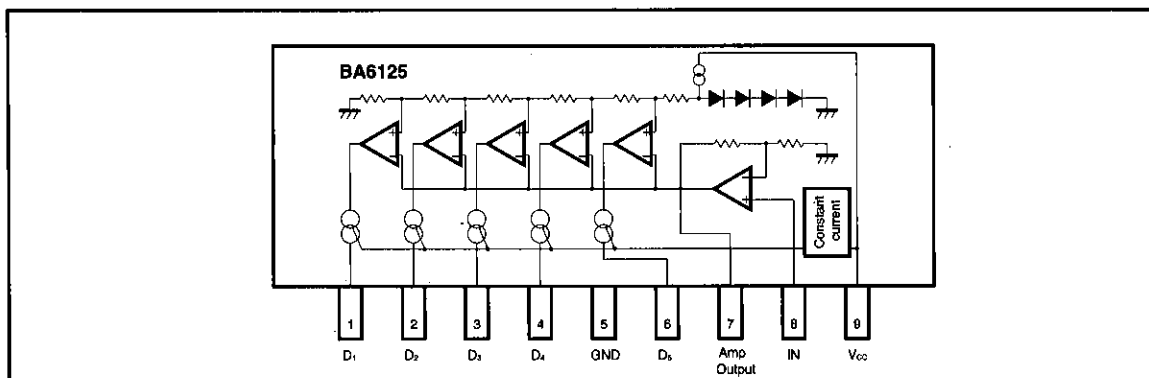

● Absolute maximum ratings (Ta = 25°C)

Parameter	Symbol	Limits	Unit
Supply voltage	V <sub>CC</sub>	18	V
Power dissipation	P <sub>d</sub>	800*	mW
Operating temperature	T <sub>opf</sub>	-25~60	°C
Storage temperature	T <sub>stg</sub>	-55~125	°C
Junction temperature	T <sub>j</sub>	150	°C

\* Reduced by 6.4mW for each increase in Ta of 1°C over 25°C.

● Electrical characteristics (unless otherwise specified Ta = 25°C, V<sub>CC</sub> = 6.0V, and f = 1kHz)

Parameter	Symbol	Min.	Typ.	Max.	Unit	Conditions	Measurement Circuit
Operating voltage range	V <sub>CC</sub>	3.5	6	16	V	—	Fig.1
Quiescent current	I <sub>Q</sub>	—	5	8	mA	V <sub>IN</sub> =0V	Fig.1
Sensitivity	V <sub>IN</sub>	—	105	—	mV <sub>rms</sub>	V <sub>C3</sub> on level	Fig.1
Control level 1	V <sub>C1</sub>	—	1/3V <sub>C3</sub>	—	mV <sub>rms</sub>	—	Fig.1
Control level 2	V <sub>C2</sub>	—	2/3V <sub>C3</sub>	—	mV <sub>rms</sub>	—	Fig.1
Control level 3	V <sub>C3</sub>	—	V <sub>C3</sub>	—	mV <sub>rms</sub>	Adjustment point	Fig.1
Control level 4	V <sub>C4</sub>	—	4/3V <sub>C3</sub>	—	mV <sub>rms</sub>	—	Fig.1
Control level 5	V <sub>C5</sub>	—	5/3V <sub>C3</sub>	—	mV <sub>rms</sub>	—	Fig.1
LED current	I <sub>LED</sub>	11	15	18.5	mA	—	Fig.1
Input bias current	I <sub>INO</sub>	—	0.3	1.0	μA	—	Fig.1

● Measurement circuit

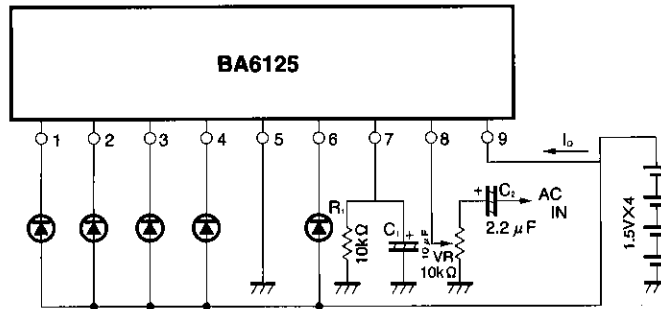

Fig. 1

Level meter drivers

Audio accessory components

●Application example

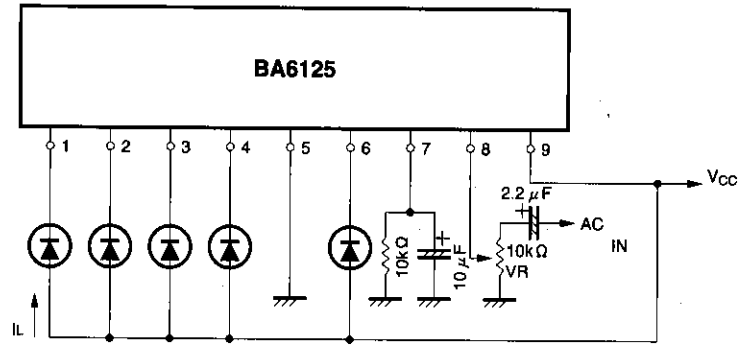

Fig. 2

●Application example

The response time (attack and release time) can be changed by varying the values of  $C_1$  and  $C_2$ .  $C_2$  is a coupling capacitor, and the potentiometer VR varies the input level. Input the voltage level that you desire for the center point, and adjust the potentiometer so that the third LED ( $V_{C3}$ ) lights. To reduce the LED current, connect a resistor either in parallel (Fig. 3 (1)) or in series (Fig. 3 (2)) with the LED. If a resistor is connected in series with the LED, the LED current will change if the supply voltage fluctuates.

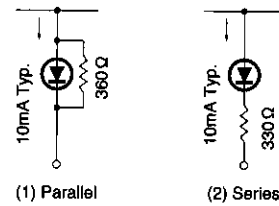

Fig. 3

Note: If the power supply voltage exceeds 9V, insert a resistor in series with the LED current supply line, or connect a heat sink so that the maximum power dissipation  $P_d$  Max. is not exceeded (see Fig. 4).

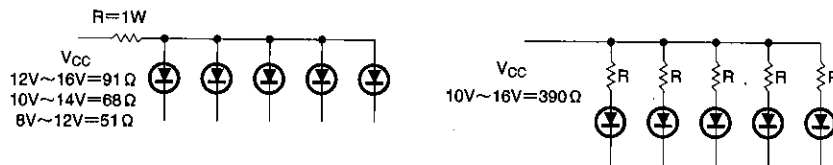

Fig. 4

●Use with DC input

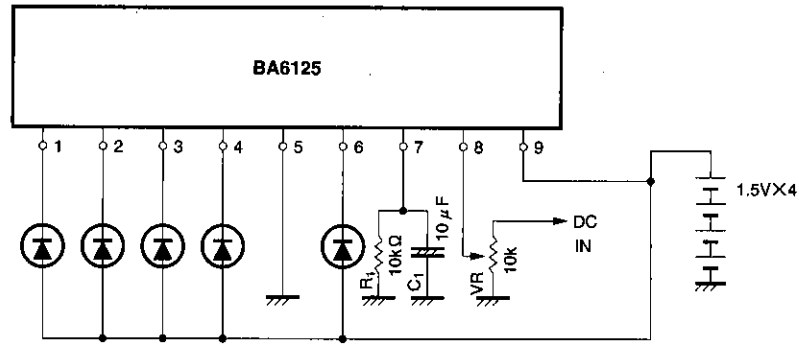

Fig. 5

Use the potentiometer shown in Fig. 5 to adjust the input level. Adjust the potentiometer so that the third LED ( $V_{C3}$ ) lights for the desired input level.

For large input levels, input via pin 7 is also possible. In this case, the dispersion in comparator level is less than in the case of input via pin 8. Note that, if the resistance value of the 100kΩ potentiometer shown in Fig. 6 is made too small, the discharge time constant determined by  $C_1$  and  $R_1$  will change, and the response time will vary. The maximum input level for pin 7 is 5V.

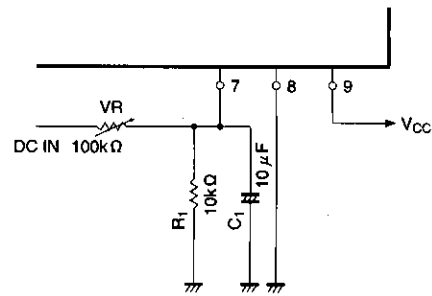
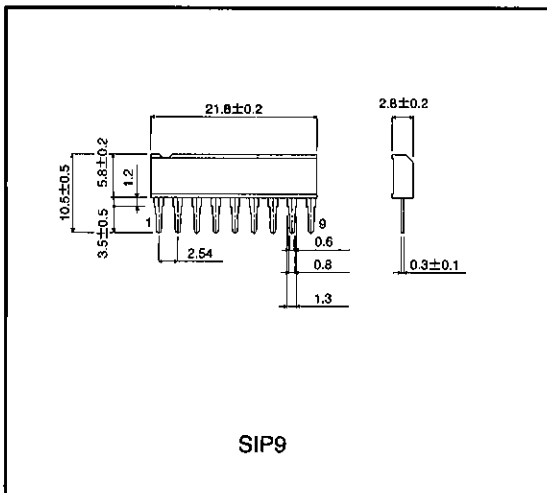

Fig. 6

Comparator level	$V_{C1}$	$V_{C2}$	$V_{C3}$	$V_{C4}$	$V_{C5}$	Unit
Pin 7 input (typ.)	0.4	0.8	1.2	1.6	2.0	V

●External dimensions (Unit: mm)



Level meter drivers

Audio accessory components