

Dual preamplifier with ALC

BA3308/BA3308F

The BA3308 and BA3308F are dual preamplifier ICs with built-in ALC circuits, and have been designed for use in stereo radio-cassette recorders and tape recorders. They come in compact 9-pin SIP (BA3308) and 14-pin MF (BA3308F) packages, and have two record/playback preamplifiers, and an ALC circuit. The preamplifiers have high gain and low distortion, and can be directly coupled to the tape head without coupling capacitors. This prevents tape head magnetization and "pop" noise generation.

A built-in rectifier means that an ALC circuit with good channel balance and large dynamic range can be constructed with addition of just an external time constant circuit.

The ICs also include power-on mute circuits that suppress "pop" noise generation.

●Applications

Stereo radio cassette recorders, cassette decks and home stereo systems and music centers

●Features

- 1) Built-in ALC rectifier diode.
- 2) Wide operation supply voltage range ($V_{CC} = 4.5V$ to $14V$).
- 3) Low current consumption ($I_a = 3.5mA$).
- 4) High gain ($G_{vo} = 80dB$).
- 5) Low distortion (THD = 0.1%).
- 6) Low noise ($V_{NIN} = 1 \mu V_{rms}$).
- 7) Input coupling capacitors and not necessary.
- 8) Good ALC channel balance.
- 9) Power-on mute circuit.
- 10) ALC dynamic range can be varied by the addition of an external input resistor.

●Absolute maximum ratings ($T_a = 25^\circ C$)

Parameter	Symbol	Limits	Unit
Supply voltage	V_{CC}	16	V
Power dissipation	BA3308	950*1	mW
	BA3308F	450*2	
Operating temperature	T_{opr}	$-25 \sim 75$	$^\circ C$
Storage temperature	T_{stg}	$-55 \sim 125$	$^\circ C$

*1 Reduced by 9.5mW for each increase in T_a of $1^\circ C$ over $25^\circ C$.

*2 Reduced by 4.5mW for each increase in T_a of $1^\circ C$ over $25^\circ C$ (when mounted on a 70mm x 70mm x 1.6mm glass-epoxy PCB).

●Recommended operating conditions ($T_a = 25^\circ C$)

Parameter	Symbol	Min.	Typ.	Max.	Unit
Supply voltage	V_{CC}	4.5	—	14	V

● Block diagram

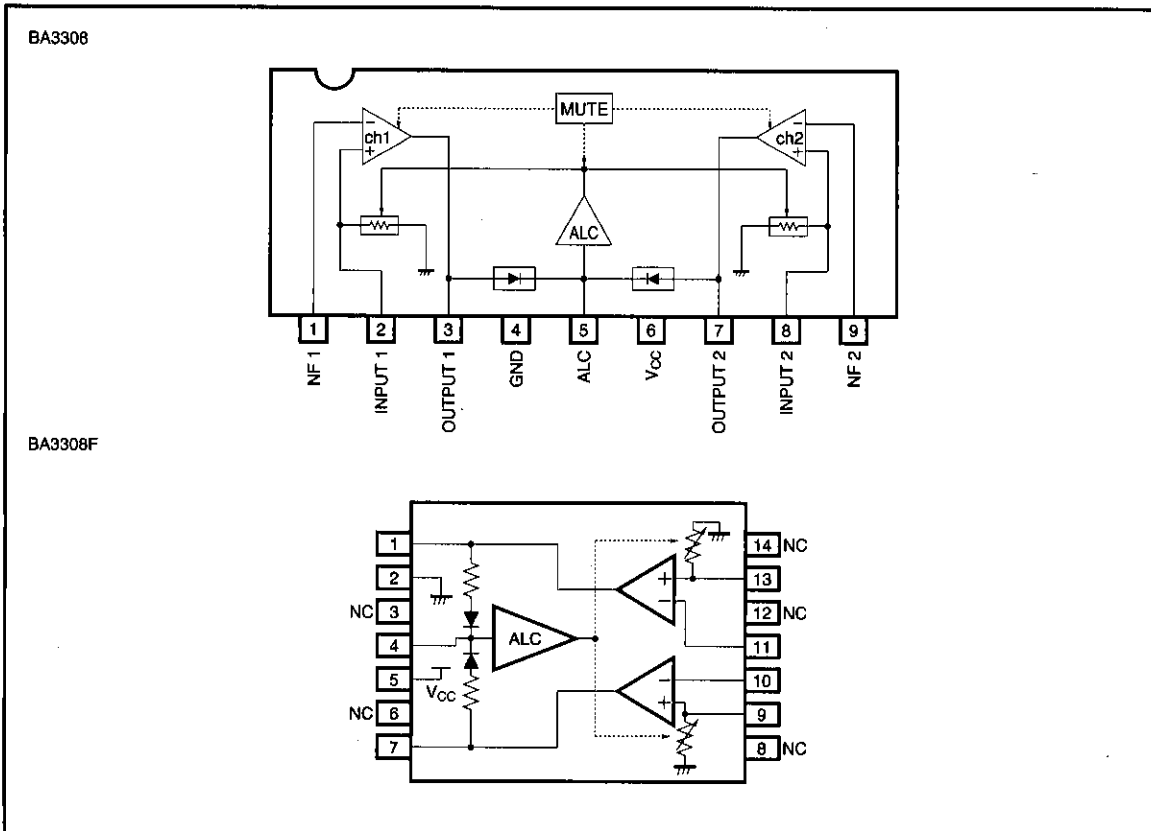

● Electrical characteristics (unless otherwise specified $T_a = 25^\circ\text{C}$, $V_{CC} = 7.0\text{V}$, $f = 1\text{kHz}$ and BPF : 20Hz to 20kHz)

Parameter	Symbol	Min.	Typ.	Max.	Unit	Conditions	Measurement Circuit
Quiescent circuit current	I_q	1.5	3.5	4.5	mA	$V_{IN} = 0V_{rms}$	Fig.1
Open-circuit voltage gain	G_{VO}	70	80	—	dB	$V_{OUT} = -10\text{dBV}$	Fig.1
Total harmonic distortion	THD	—	0.1	0.3	%	NAB34dB, $V_{OUT} = 40\text{mV}_{rms}$	Fig.1
Input resistance	R_{IN}	15	25	45	$k\Omega$	—	Fig.1
Maximum output voltage	V_{OM}	0.6	1.2	—	V_{rms}	THD=1%	Fig.1
Input conversion-noise voltage	V_{NIN}	—	1.0	2.0	μV_{rms}	Conversion with $R_0 = 2.2k\Omega$ and NAB 34dB at 1kHz	Fig.1
ALC range	ALC	40	45	—	dB	$R_G = 3.9k\Omega$, $V_{IN} = -70\text{dBV}$ reference, THD = 3%	Fig.1
ALC Channel balance	ΔALC	—	0	2.5	dB	$V_{IN} = -60\text{dBV}$, -30dBV	Fig.1
Channel separation	CS	60	75	—	dB	$V_o = 0\text{dBV}$, NAB34dB	Fig.1

Preamplifiers

Low-frequency amplifiers

● Measurement circuit

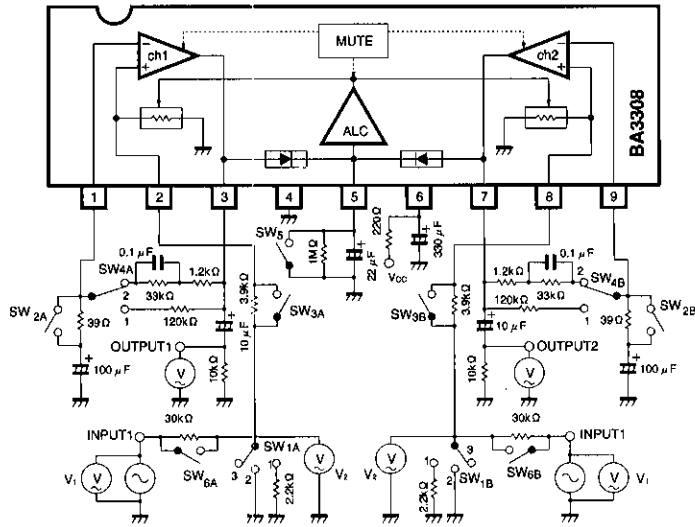

Fig. 1

● Application example

● Application example circuit PCB (copper side)

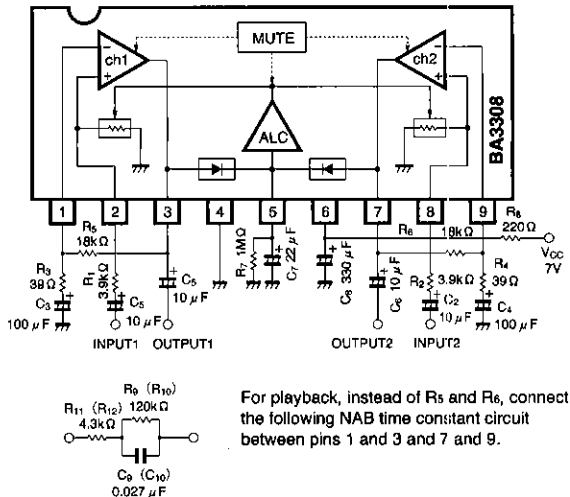

Fig. 2

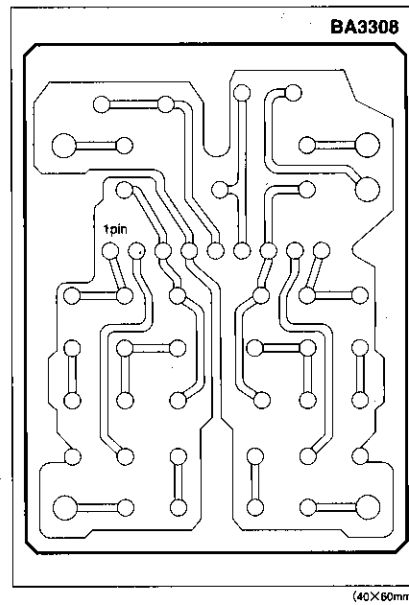
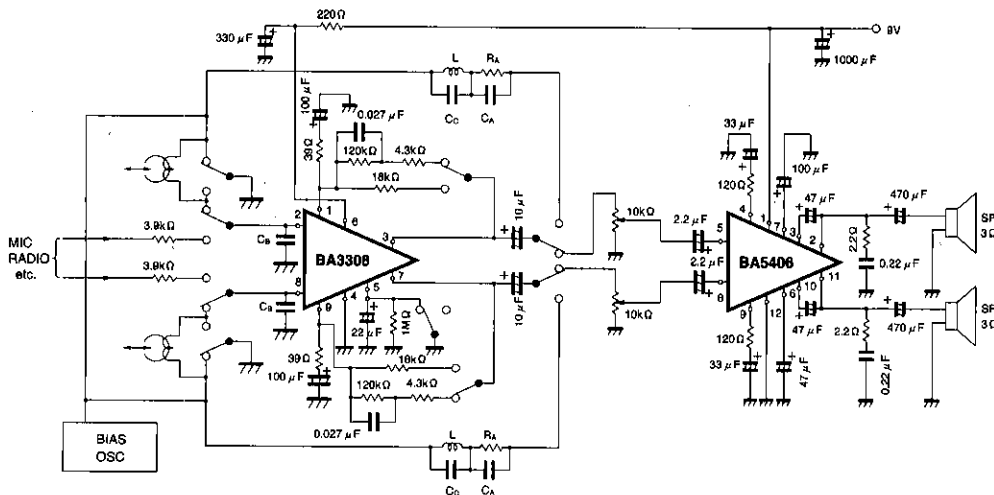

Fig. 3

● Total application circuit



- Notes:
- (1) Switches are in the playback positions.
 - (2) Set the values of R_A and C_A depending on the characteristics of the playback/recording head.
 - (3) The capacitor C_a is for head resonance treble compensation during playback, and prevention of high-frequency noise. The recommended value is about 1000pF.
 - (4) L and C_c are a bias trap.

Fig. 4

● Circuit operation

(1) Recording

1) Recording amplifier (See Fig. 5)

The channel 1 and 2 amplifier input stages of the BA3308 (pins 8 and 2) can be direct-coupled, and the input coupling capacitors C_1 and C_2 are not particularly required.

The voltage gain of the recording amplifier is given by $G_v = R_5 / R_3$, but as a "pop" noise is generated when power is applied, (see "operation notes"), use the time constant circuit values given for C_3 and R_3 (C_4 and R_4) in the application example circuit diagram, or values close to these, and adjust the voltage gain with R_5 (R_6). R_5 (R_6) is also the DC bias feedback resistor, and is connected between pin 3 (7), and the output capacitor C_5 (C_6).

2) ALC (See Fig. 6)

The BA3308 includes a signal rectifier block and electronic potentiometers required for the ALC. In the signal rectifier block, a comparator compares the DC output voltage component of the output stage signal (pins 3 and 7) to a voltage of $4.5V_F$

($1V_F$ is about 0.7V, so $4.5V_F$ is approximately 3V), and if it is above this, the comparator switches on, and charges the smoothing capacitor C_7 . The operating point of the amplifier's ch1 and ch2 output stages is fixed at $3V_F$, so when the signal output voltage is $1.5V_F$ (an effective value of approximately 0.75V), the comparator goes on, DC signals for electronic potentiometer control are generated, and the ALC starts operating.

The electronic potentiometers are connected between the input lines (pins 2 and 8) and GND, and the input signals is attenuated by the ratio of the electronic potentiometer resistances and the external resistors R_1 and R_2 . The range of the ALC can be varied by the values of R_1 and R_2 , but if they are too large the S/N ratio will worsen. Sufficient ALC range should be obtained with R_1 and R_2 values of around several kohms. C_7 and R_7 connected to pin 5 set the ALC attack and recovery times. The larger the values of these constants, the longer the recovery time, and the smaller the value of C_7 the shorter the attack time.

Preamplifiers

Low-frequency amplifiers

(2) Playback (See Fig. 7)

During playback, the ch1 and ch2 amplifiers are used as NAB equalizer amplifiers, and time constant circuits are connected between pins 1 and 3, and 7 and 9 in the negative-feedback section to give the NAB characteristics. The voltage gain is given by :

$$G_V = |R_{11} + R_9 / (1 + j\omega C_9 \cdot R_9) | / R_3$$

In the same way as for recording, the NAB time constant circuit is adjusted to give the required gain (to prevent generation of a "pop" noise

when power is applied). The output stage (pins 3 and 7) operating point is fixed at 3V_F. Therefore, as indicated in the V_{Max.} vs. V_{CC} characteristic (see Fig. 19), even if the V_{CC} voltage is made larger than 5V, the maximum output voltage will not exceed 1.2V (typ.). The ALC circuit is not required for playback, so pin 5 is grounded. The S/N ratio during playback is better if the external resistors R₁ and R₂ that are connected to the input pins (2 and 8) for recording are switched out.

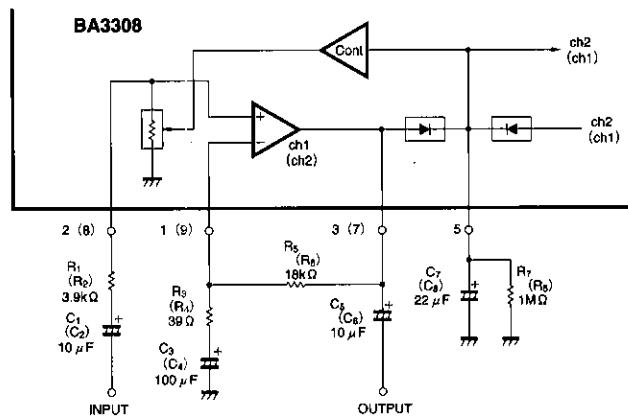

Fig. 5

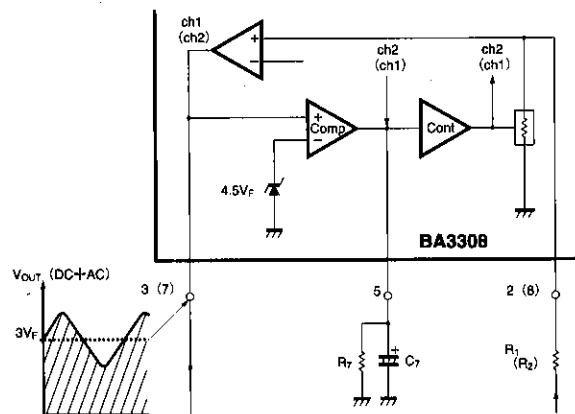

Fig. 6

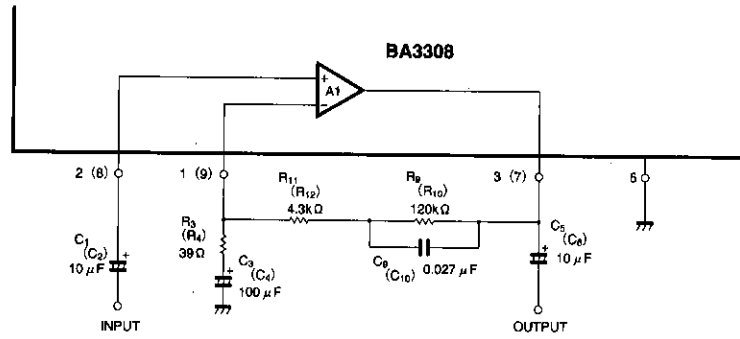

Fig. 7

● Operation notes

The BA3308 has a built-in power-on mute circuit to prevent generation of a “pop” sound when the power is applied. The generation of the “pop” sound is prevented by the DC blocking capacitors C₃ and C₄ connected to pins 1 and 9, and the charge time required

for the ripple filter capacitor C₈ that is connected to pin 6.

To ensure correct operation of this circuit, use the values given in the application example circuit for C₃, C₄, R₃, R₄, C₈ and R₈.

● Application example circuit PCB component layout (component side)

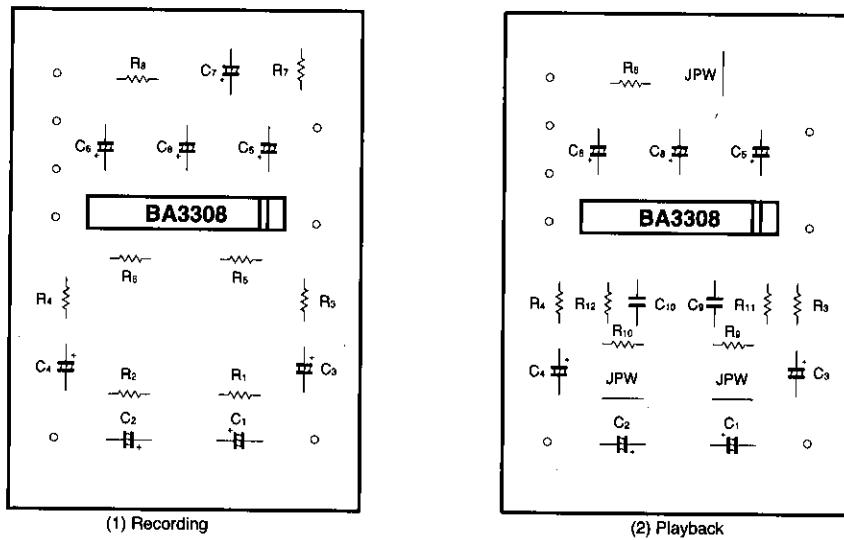

Fig. 8

Preamplifiers

Low-frequency amplifiers

● Electrical characteristics curves

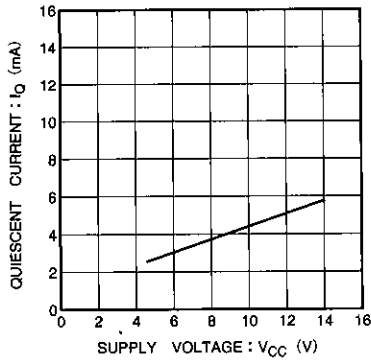

Fig. 9 Quiescent current vs. supply voltage

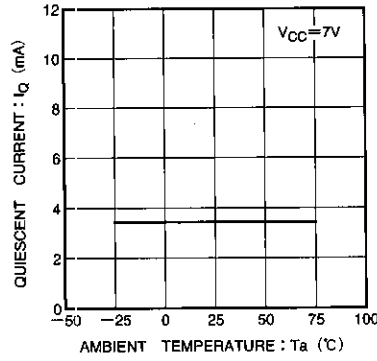

Fig. 10 Quiescent current vs. ambient temperature

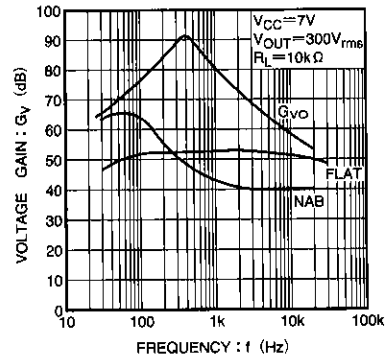

Fig. 11 Voltage gain vs. frequency

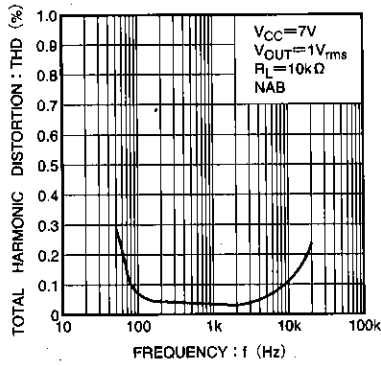

Fig. 12 Total harmonic distortion vs. frequency

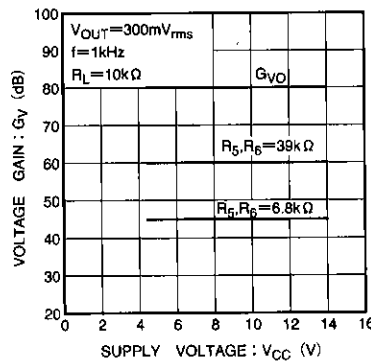

Fig. 13 Voltage gain vs. supply voltage

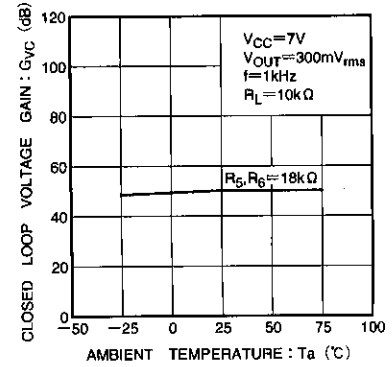

Fig. 14 Closed-circuit voltage gain vs. ambient temperature

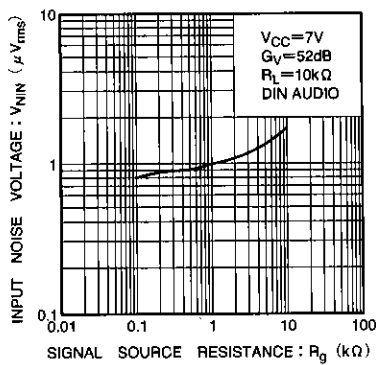

Fig. 15 Input noise voltage vs. signal source resistance

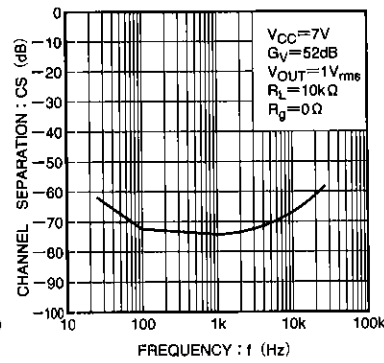

Fig. 16 Channel separation vs. frequency

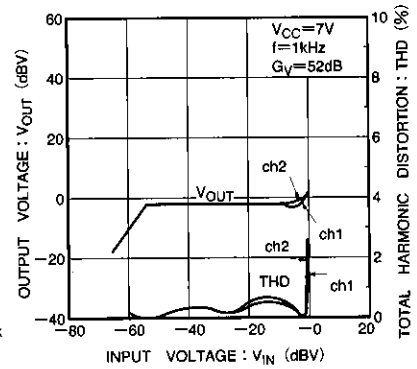

Fig. 17 ALC characteristics

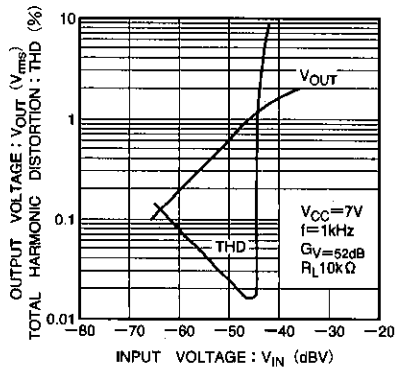

Fig. 18 Input/output characteristics

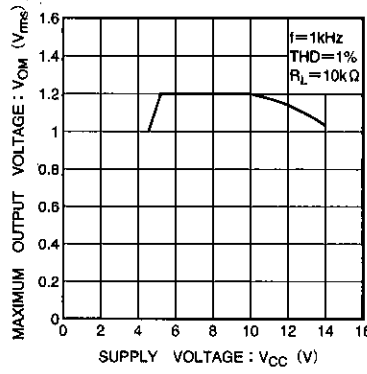

Fig. 19 Maximum output voltage vs. supply voltage

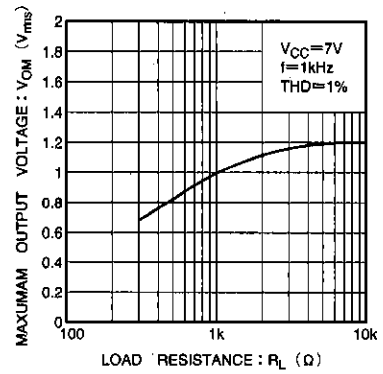
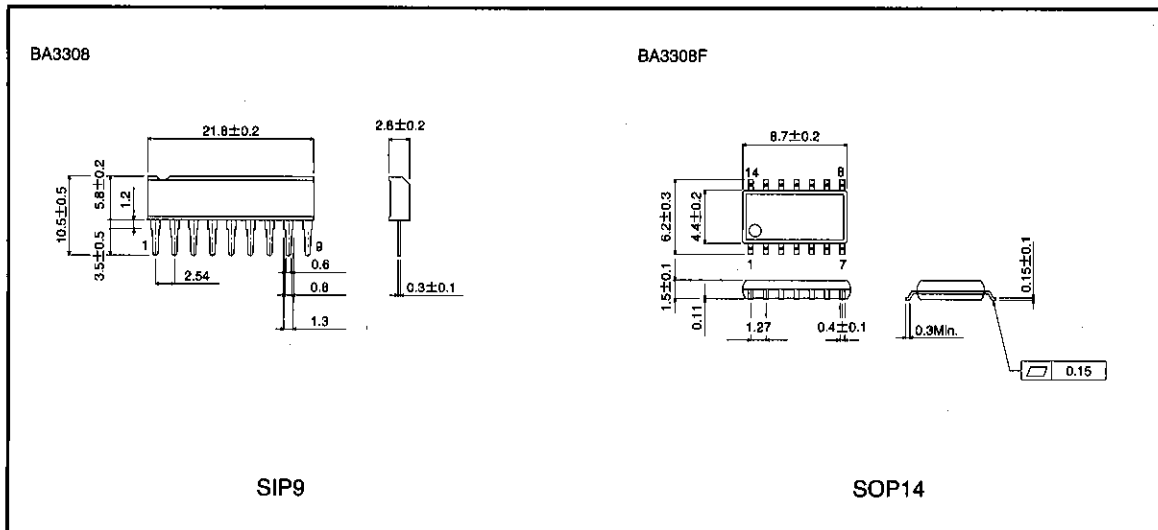

Fig. 20 Maximum output voltage vs. load resistance

● External dimensions (Unit: mm)



Preamplifiers

Low-frequency amplifiers