

SANYO	No. 4786	LA5609
Multi-Function Voltage Regulator for Radio Cassette Recorders with CD Player		

Overview

The LA5609 is a multi-function multi-voltage power supply that includes a built-in on/off function. The LA5609 provides dedicated outputs for motors, audio systems, CD drive, radio, microprocessor, and loading drives, thus making it optimal for use as the system power supply in radio cassette recorders with CD player.

Functions

- Power supply systems for radio cassette recorders with CD player
- Miniature electronic equipment
- Low-saturation regulator (14.5 V/1.2 A, 9 V/300 mA, 7.5 V/800 mA)
- High-precision power supply (two 5 V/220 mA systems, 5 V/100 mA, 8 V/800 mA)
- Limiter power supply (9 V/60 mA)

Features

- Supports end-product miniaturization by the provision of built-in control circuits.
- Provides reduced internal power dissipation by the adoption of a low-saturation regulator.
- Built-in output current limiter prevents IC destruction due to output shorts.

Package Dimensions

unit: mm

3109-SIP18H

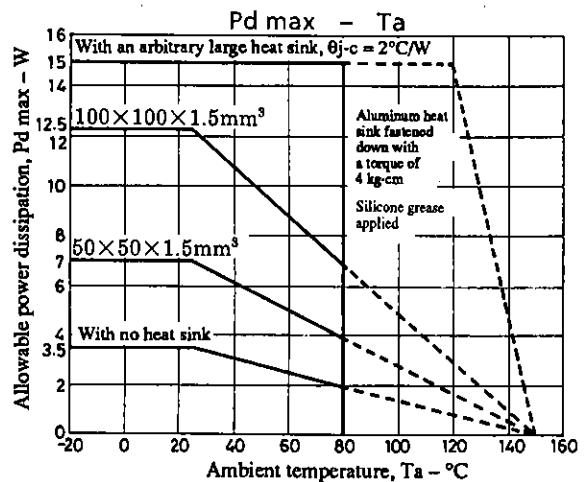
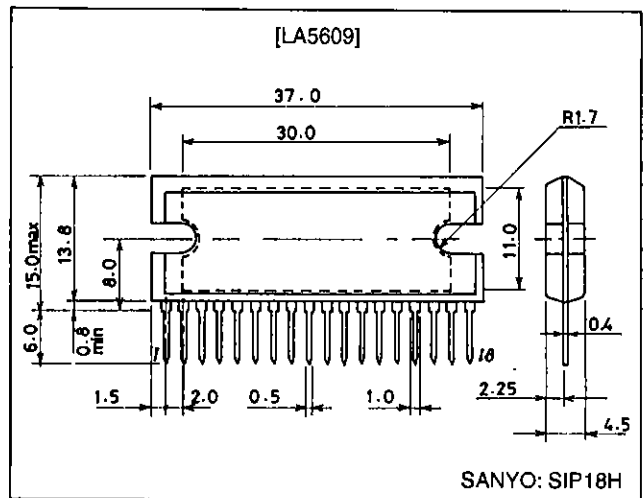

Specifications

Maximum Ratings at Ta = 25°C

Parameter	Symbol	Conditions	Ratings	Unit
Input voltage	V _{CC} max		24	V
V _{REF} pin voltage	V _{REF}		6	V
POWER CONT pin voltage	V _{CONT} max		6	V
AC STBY pin voltage	V _{AC} max		6	V
MODE SW pin voltage	V _{MODE} max		6	V
Allowable power dissipation	P _d max	With no heat sink	3.5	W
Operating temperature	T _{opr}		-20 to +80	°C
Storage temperature	T _{stg}		-55 to +150	°C

Operating Conditions at Ta = 25°C

Parameter	Symbol	Conditions	Ratings	Unit
Input voltage	V _{CC}		6.5 to 22	V
Input voltage	V _{REF}		4.5 to 5.5	V
Motor 14.5 V output current	I _O MOT		0 to 1.2	A
Audio 9 V output current	I _O AUD		0 to 300	mA
Digital 5 V output current	I _O DIGI		0 to 220	mA
CD 5 V output current	I _O CDS		0 to 220	mA
CD 8 V output current	I _O CDB		0 to 0.8	A
Radio 5 V output current	I _O RAD		0 to 100	mA
Loading 7.5 V output current	I _O LOAD		0 to 0.8	A
9 V limiter output current	I _O LIM		0 to 60	mA

Operating Characteristics at Ta = 25°C in the specified test circuit

Parameter	Symbol	Conditions	min	typ	max	Unit
[No Load Currents]						
V _{CC} quiescent current	I _{CC}	V _{CC} = 12 V, Power cont.: L, 5 V _{REF} : L			500	μA
Influx 1 V _{REF} 5 V input current	I _{REF1}	V _{CC} = 0 V, Power cont.: L			10	μA
Influx 2 V _{REF} 5 V input current	I _{REF2}	V _{CC} = 12 V, Power cont. = 5 V			700	μA
[Motor 14.5 V Regulator Block] V _{CC} = 16 V, I _O MOT = 1.2 A, Power cont. = 5 V						
Output voltage	V _O MOT		14.0	14.5	15.0	V
Dropout voltage	V _{DROP-MOT}	V _{CC} = 14 V, I _O MOT = 600 mA		0.4	0.8	V
Line regulation	ΔV _{OLN-MOT}	V _{CC} = 16 to 22 V		30	300	mV
Load regulation	ΔV _{OLD-MOT}	I _O MOT = 0 to 1.2 A		200	800	mV
Peak output current	I _{OP-MOT}		1.2			A
Short circuit output current	I _{OSC-MOT}			300		mA
[Audio 9 V Regulator Block] V _{CC} = 11 V, I _O AUD = 300 mA, Power cont. = 5 V						
Output voltage	V _O AUD		8.5	9.0	9.5	V
Dropout voltage	V _{DROP-AUD}	V _{CC} = 8.5 V, I _O AUD = 150 mA		0.2	0.8	V
Line regulation	ΔV _{OLN-AUD}	V _{CC} = 11 to 22 V		100	400	mV
Load regulation	ΔV _{OLD-AUD}	I _O AUD = 0 to 300 mA		100	400	mV
Peak output current	I _{OP-AUD}		300			mA
Short circuit output current	I _{OSC-AUD}			50		mA
Ripple rejection	R _{REJ-AUD}	f = 120 Hz, 10 V ≤ V _{CC} ≤ 15 V, C = 1 μF		60		dB

Continued on next page.

LA5609

Continued from preceding page.

Parameter	Symbol	Conditions	min	typ	max	Unit
[Digital 5.0 V Regulator Block] Power cont. = 5 V						
Output voltage	$V_{O\ DIGI}$	$V_{CC} = 16\ V, I_{O\ DIGI} = 100\ mA$	4.95	5.05	5.15	V
Dropout voltage	$V_{DROD-DIGI}$	$V_{CC} = 4.9\ V, I_{O\ DIGI} = 110\ mA$		0.6	1.4	V
Line regulation	$\Delta V_{OLN1-DIGI}$	$V_{CC} = 16\ to\ 20\ V, I_{O\ DIGI} = 220\ mA$	0	40	60	mV
	$\Delta V_{OLN2-DIGI}$	$V_{CC} = 16\ to\ 8\ V, I_{O\ DIGI} = 220\ mA$	-100	-70	0	mV
	$\Delta V_{OLN3-DIGI}$	$V_{CC} = 16\ to\ 20\ V, I_{O\ DIGI} = 0\ mA$	-20	0	+20	mV
	$\Delta V_{OLN4-DIGI}$	$V_{CC} = 16\ to\ 8\ V, I_{O\ DIGI} = 0\ mA$	-20	0	+20	mV
Load regulation	$\Delta V_{OLD1-DIGI}$	$V_{CC} = 16\ V, I_{O\ DIGI} = 100\ to\ 220\ mA$	0	40	60	mV
	$\Delta V_{OLD2-DIGI}$	$V_{CC} = 16\ V, I_{O\ DIGI} = 100\ to\ 0\ mA$	-60	-40	0	mV
Peak output current	$I_{OP-DIGI}$	$V_{CC} = 6.5\ V$	220	260		mA
Short circuit output current	$I_{OSC-DIGI}$	$V_{CC} = 6.5\ V$		260		mA
[CD 5.0 V Regulator Block] Power cont. = 5 V, Mode SW = 5 V						
Output voltage	$V_{O\ CD5}$	$V_{CC} = 16\ V, I_{O\ CD5} = 100\ mA$	4.9	5.0	5.1	V
Dropout voltage	$V_{DROD-CD5}$	$V_{CC} = 4.9\ V, I_{O\ CD5} = 110\ mA$		0.6	1.4	V
Line regulation	$\Delta V_{OLN1-CD5}$	$V_{CC} = 16\ to\ 20\ V, I_{O\ CD5} = 220\ mA$	0	40	60	mV
	$\Delta V_{OLN2-CD5}$	$V_{CC} = 16\ to\ 8\ V, I_{O\ CD5} = 220\ mA$	-100	-70	0	mV
	$\Delta V_{OLN3-CD5}$	$V_{CC} = 16\ to\ 20\ V, I_{O\ CD5} = 0\ mA$	-20	0	+20	mV
	$\Delta V_{OLN4-CD5}$	$V_{CC} = 16\ to\ 8\ V, I_{O\ CD5} = 0\ mA$	-20	0	+20	mV
Load regulation	$\Delta V_{OLD1-CD5}$	$V_{CC} = 16\ V, I_{O\ CD5} = 100\ to\ 220\ mA$	0	40	60	mV
	$\Delta V_{OLD2-CD5}$	$V_{CC} = 16\ V, I_{O\ CD5} = 100\ to\ 0\ mA$	-60	-40	0	mV
Peak output current	I_{OP-CD5}	$V_{CC} = 6.5\ V$	220	260		mA
Short circuit output current	$I_{OSC-CD5}$	$V_{CC} = 6.5\ V$		260		mA
[CD 8.0 V Regulator Block] $V_{CC} = 9.5\ V, I_{O\ CD8} = 800\ mA$, Power cont. = 5 V, Mode SW = 5 V						
Output voltage	$V_{O\ CD8}$		7.5	8.0	8.5	V
Dropout voltage	$V_{DROD-CD8}$	$V_{CC} = 7.5\ V, I_{O\ CD8} = 400\ mA$		0.6	1.4	V
Line regulation	$\Delta V_{OLN-CD8}$	$V_{CC} = 9.5\ to\ 22\ V$		20	200	mV
Load regulation	$\Delta V_{OLD-CD8}$	$I_{O\ CD8} = 0\ to\ 800\ mA$		100	250	mV
Peak output current	I_{OP-CD8}		0.8	1.1		A
[Radio 5.0 V Regulator Block] Power cont. = 5 V						
Output voltage	$V_{O\ RAD}$	$V_{CC} = 16\ V, I_{O\ RAD} = 50\ mA$	4.9	5.0	5.1	V
Dropout voltage	$V_{DROD-RAD}$	$V_{CC} = 4.9\ V, I_{O\ RAD} = 50\ mA$		0.6	1.4	V
Line regulation	$\Delta V_{OLN1-RAD}$	$V_{CC} = 16\ to\ 20\ V, I_{O\ RAD} = 100\ mA$	0	20	40	mV
	$\Delta V_{OLN2-RAD}$	$V_{CC} = 16\ to\ 8\ V, I_{O\ RAD} = 100\ mA$	-70	-40	0	mV
	$\Delta V_{OLN3-RAD}$	$V_{CC} = 16\ to\ 20\ V, I_{O\ RAD} = 0\ mA$	-10	0	+10	mV
	$\Delta V_{OLN4-RAD}$	$V_{CC} = 16\ to\ 8\ V, I_{O\ RAD} = 0\ mA$	-10	0	+10	mV
Load regulation	$\Delta V_{OLD1-RAD}$	$V_{CC} = 16\ V, I_{O\ RAD} = 50\ to\ 100\ mA$	0	20	40	mV
	$\Delta V_{OLD2-RAD}$	$V_{CC} = 16\ V, I_{O\ RAD} = 50\ to\ 0\ mA$	-40	-20	0	mV
Peak output current	I_{OP-RAD}	$V_{CC} = 6.5\ V$	100	160		mA
Short circuit output current	$I_{OSC-RAD}$	$V_{CC} = 6.5\ V$		160		mA
[Loading 7.5 V Regulator Block] Power cont. = 5 V						
REG SET voltage	V_{REGS}	$V_{CC} = 16\ V, I_{O\ LOAD} = 400\ mA$	1.27	1.31	1.35	V
Dropout voltage	$V_{DROD-LOAD}$	$V_{CC} = 7.3\ V, I_{O\ LOAD} = 400\ mA$		0.4	0.8	V
Line regulation	$\Delta V_{OLN1-LOAD}$	$V_{CC} = 16\ to\ 20\ V, I_{O\ LOAD} = 800\ mA$	0	10	20	mV
	$\Delta V_{OLN2-LOAD}$	$V_{CC} = 16\ to\ 9\ V, I_{O\ LOAD} = 800\ mA$	-20	-10	0	mV
	$\Delta V_{OLN3-LOAD}$	$V_{CC} = 16\ to\ 20\ V, I_{O\ LOAD} = 0\ mA$	-10	0	+10	mV
	$\Delta V_{OLN4-LOAD}$	$V_{CC} = 16\ to\ 9\ V, I_{O\ LOAD} = 0\ mA$	-10	0	+10	mV
Load regulation	$\Delta V_{OLD1-LOAD}$	$V_{CC} = 16\ V, I_{O\ LOAD} = 400\ to\ 800\ mA$	0	10	20	mV
	$\Delta V_{OLD2-LOAD}$	$V_{CC} = 16\ V, I_{O\ LOAD} = 400\ to\ 0\ mA$	-20	-10	0	mV
Peak output current	$I_{OP-LOAD}$	$V_{CC} = 9\ V$	0.8			A
Short circuit output current	$I_{OSC-LOAD}$	$V_{CC} = 9\ V$		200		mA

Continued on next page.

LA5609

Continued from preceding page.

Parameter	Symbol	Conditions	min	typ	max	Unit
[9.0 V Limiter Block] $V_{CC} = 11\text{ V}$, $I_{O\text{ LIM}} = 60\text{ mA}$						
Output voltage	$V_{O\text{ LIM}}$		8.0	9.0	9.5	V
Dropout voltage	$V_{\text{DROP-LIM}}$	$V_{CC} = 8\text{ V}$		1.0		V
Peak output current	$I_{\text{OP-LIM}}$		60	150		mA
Short circuit output current	$I_{\text{OSC-LIM}}$			200		mA
[Mode Switch] $V_{CC} = 12\text{ V}$						
Voltage with radio mode on	$V_{\text{MTH H}}$	Voltage when the radio output is switched high	1.1	1.4	1.7	V
Voltage with radio mode off	$V_{\text{MTH L}}$	Voltage when the radio output is switched low	2.9	3.1	3.3	V
Voltage with CD mode on	$V_{\text{RTH H}}$	Voltage when the CD 5 V and CD 8 V are switched high	2.9	3.1	3.3	V
Input impedance	Z_i		16.8	24	31.2	k Ω
[Power Control] $V_{CC} = 12\text{ V}$						
Output on control voltage	$V_{\text{I CONT-ON}}$		3.0			V
Output off control voltage	$V_{\text{I CONT-OFF}}$				2.0	V
[AC standby]						
Output on control voltage	$V_{\text{I AC-ON}}$		2.0			V
Output off control voltage	$V_{\text{I AC-OFF}}$				1.0	V
[5 V System Regulator Block] $V_{CC} = 16\text{ V}$, $I_{O\text{ DIGI}} = I_{O\text{ CD5}} = 100\text{ mA}$, $I_{O\text{ RAD}} = 50\text{ mA}$						
Difference between output voltages	ΔV_{DEF}			0	0.15	V

Timing Chart

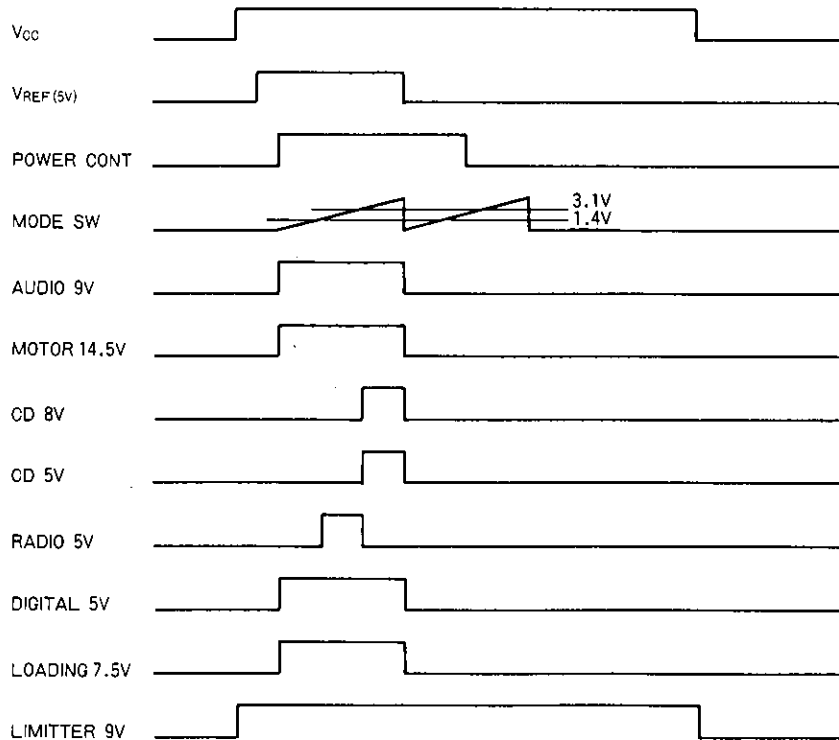

LA5609

Function Table

V _{REF}	Power cont.	Mode SW	V _{OUT}						
			Audio 9 V	Motor 14.5 V	Digital 5 V	Loading 7.5 V	CD 8 V/ CD 5 V	Radio 5 V	Limiter 9 V
L	L	L (0 V)			L		L	L	H
		M (2.5 V)			L		L	L	H
		H (5 V)			L		L	L	H
	H	L (0 V)			L		L	L	H
		M (2.5 V)			L		L	L	H
		H (5 V)			L		L	L	H
H	L	L (0 V)			L		L	L	H
		M (2.5 V)			L		L	L	H
		H (5 V)			L		L	L	H
	H	L (0 V)			H		L	L	H
		M (2.5 V)			H		L	H	H
		H (5 V)			H		H	L	H

Test Circuit

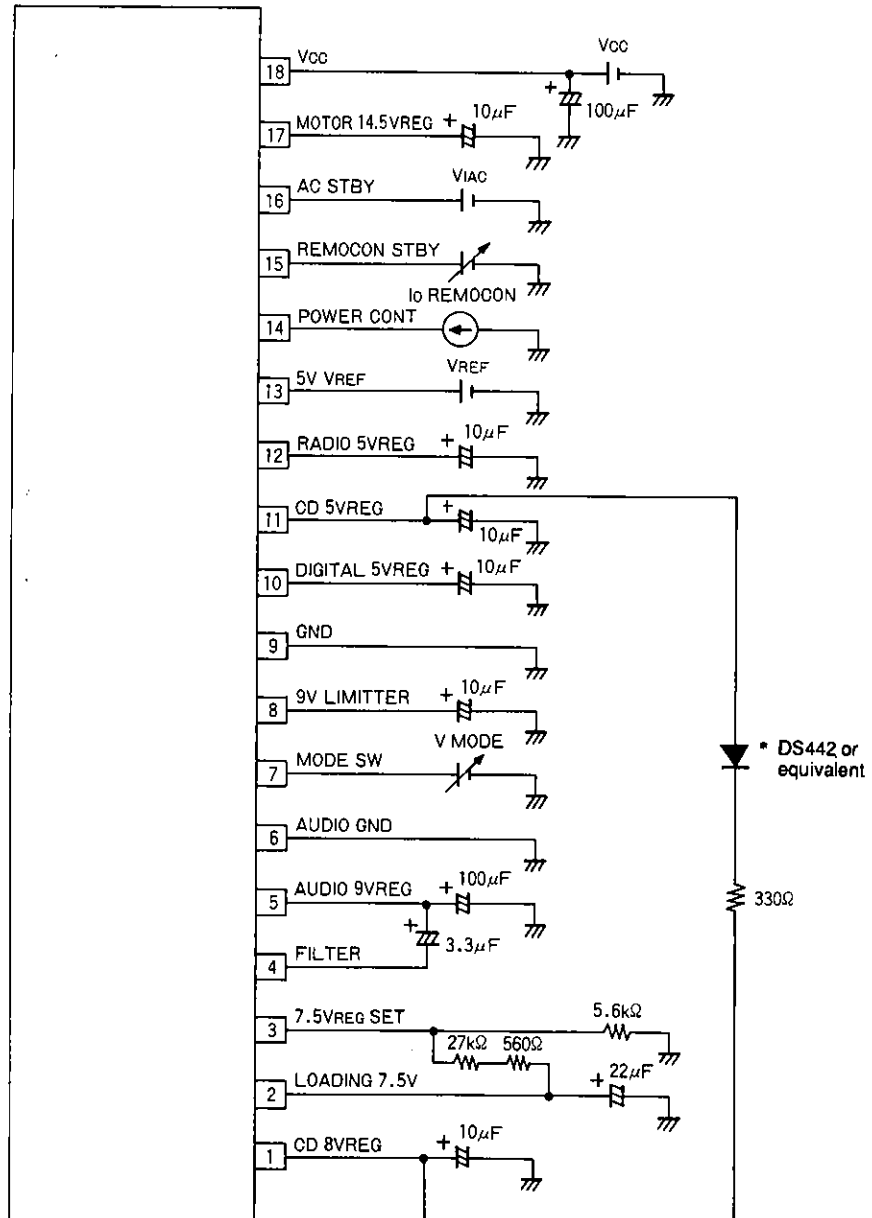

Note: * This diode is required for bringing up the CD 8 V regulator.

Sample Application Circuit

Unit (capacitance: F)

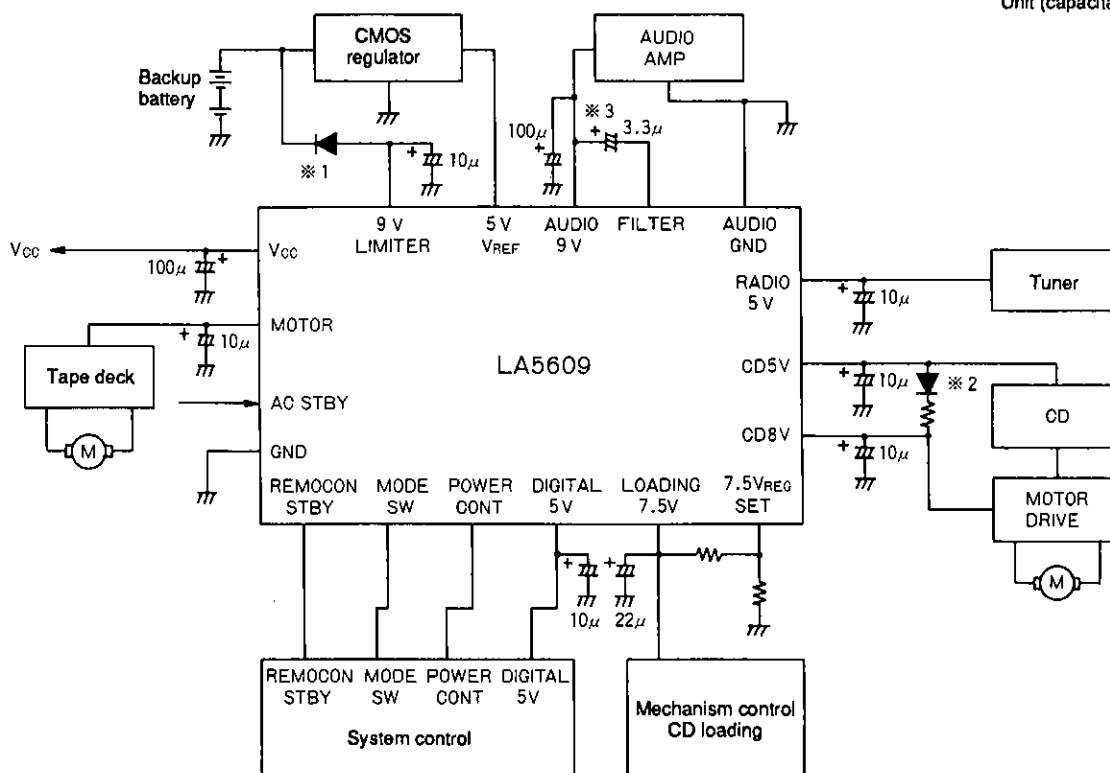

- Note: 1. The diode in the 9 V limiter block must be added. It is required for preventing current from flowing into the 9 V limiter from the backup battery when V_{CC} is off.
2. The diode and resistor between the CD 5 V and CD 8 V blocks must be added. It is required to bring up the CD 8 V regulator.
3. External noise can be limited and ripple rejection can be improved by adding an electrolytic capacitor between the audio 9 V and the filter circuits.
4. The electrolytic capacitors between V_{CC} and GND and between each V_O and GND should have capacitances at least those shown in the diagram. Use Sanyo HW Series aluminum electrolytic capacitors or equivalent products.

Equivalent Circuit Block Diagram

Unit (resistance: Ω)

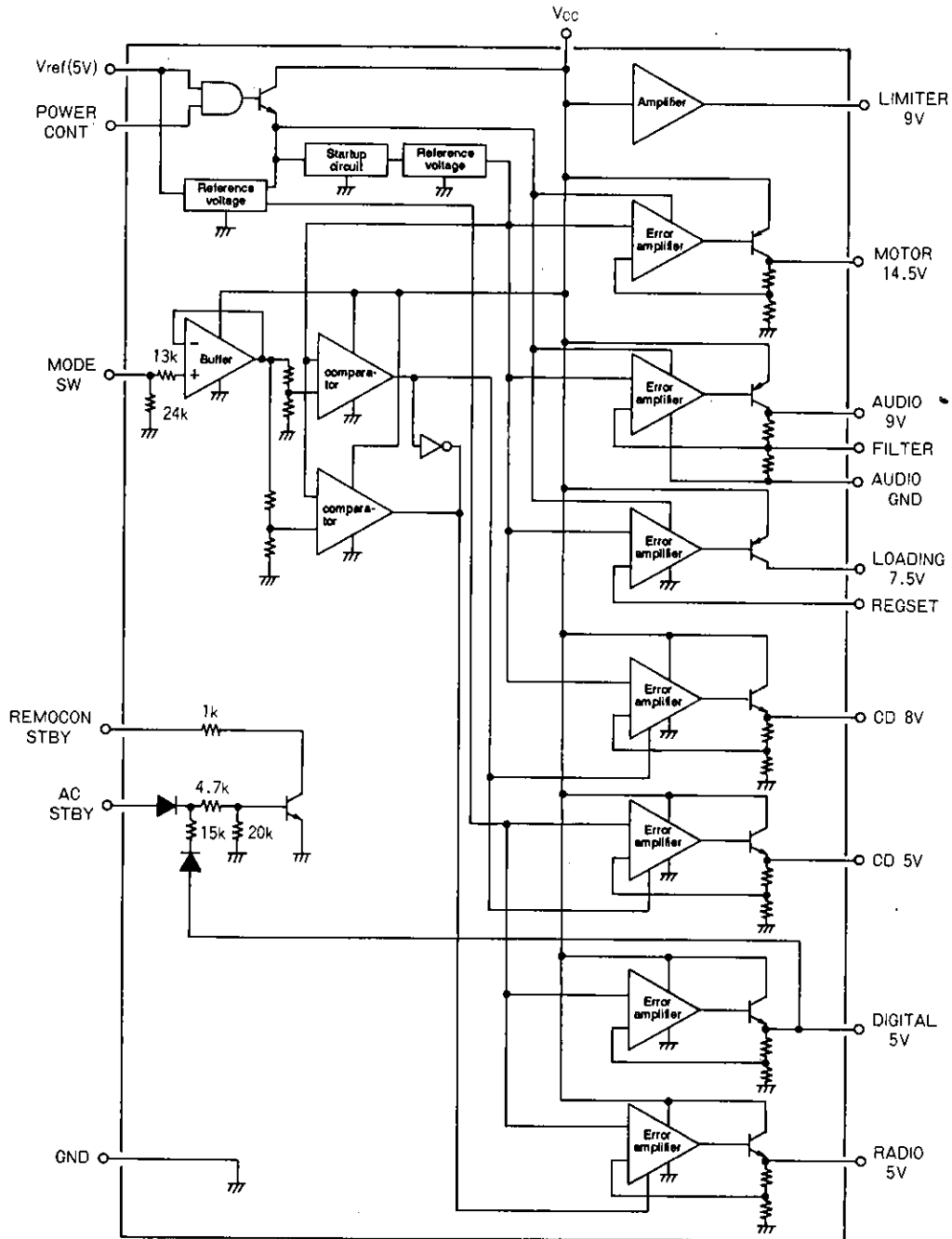

- No products described or contained herein are intended for use in surgical implants, life-support systems, aerospace equipment, nuclear power control systems, vehicles, disaster/crime-prevention equipment and the like, the failure of which may directly or indirectly cause injury, death or property loss.
- Anyone purchasing any products described or contained herein for an above-mentioned use shall:
 - ① Accept full responsibility and indemnify and defend SANYO ELECTRIC CO., LTD., its affiliates, subsidiaries and distributors and all their officers and employees, jointly and severally, against any and all claims and litigation and all damages, cost and expenses associated with such use;
 - ② Not impose any responsibility for any fault or negligence which may be cited in any such claim or litigation on SANYO ELECTRIC CO., LTD., its affiliates, subsidiaries and distributors or any of their officers and employees jointly or severally.
- Information (including circuit diagrams and circuit parameters) herein is for example only; it is not guaranteed for volume production. SANYO believes information herein is accurate and reliable, but no guarantees are made or implied regarding its use or any infringements of intellectual property rights or other rights of third parties.