

4-channel BTL driver for CD players

BA6790FP/BA6791FP

The BA6790FP and BA6791FP are 4-channel BTL drivers for CD player actuators and motors. These ICs have internal 5 V regulators and general purpose operational amplifiers, and are mounted to a 28-pin HSOP package, allowing for the miniaturization of applications.

● Applications

CD players and portable CD

● Features

- 1) 4-channel BTL driver.
- 2) HSOP 28-pin package allows for miniaturization of applications.
- 3) Wide dynamic range. (typically 5.4V when $V_{CC}=8V$ and $R_L=8\Omega$)
- 4) Internal thermal shutdown circuit.
- 5) Gain is adjustable with a single attached resistor.
- 6) Internal 5V regulator. (requires attached PNP transistor)
- 7) Internal general purpose operational amplifier.

● Block diagram

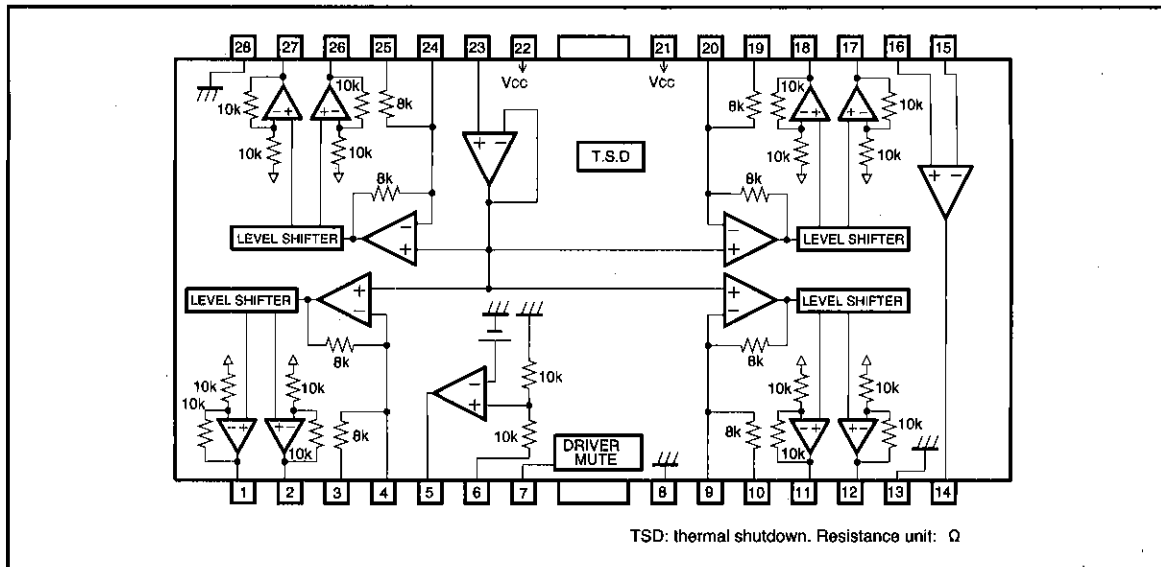

●Pin description

Pin No.	Pin name	Description	Pin No.	Pin name	Description
1	VO1 (-)	Driver CH1 negative output	15	OP IN (-)	Operational amplifier input, negative
2	VO1 (+)	Driver CH1 positive output	16	OP IN (+)	Operational amplifier input, positive
3	VIN1	Driver CH1 input	17	VO3 (-)	Driver CH3 negative output
4	VIN1'	Driver CH1 input, gain adjustment pin	18	VO3 (+)	Driver CH3 positive output
5	REG-B	Connect to external transistor base	19	VIN3	Driver CH3 input
6	REG OUT	Constant voltage output, connects to external transistor collector	20	VIN3'	Driver CH3 gain adjustment pin
7	MUTE	Mute control pin	21	Vcc	Power supply
8	GND	Ground	22	Vcc	Power supply
9	VIN2'	Driver CH2 input, gain adjustment pin	23	BIAS IN	Bias amplifier input
10	VIN2	Driver CH2 input	24	VIN4'	Driver CH4 gain adjustment pin
11	VO2 (+)	Driver CH2 positive output	25	VIN4	Driver CH4 input
12	VO2 (-)	Driver CH2 negative output	26	VO4 (+)	Driver CH4 positive output
13	GND	Substrate ground	27	VO4 (-)	Driver CH4 negative output
14	OP OUT	Operational amplifier output	28	GND	Substrate ground

Note: Driver positive output and driver negative output indicate polarity relative to input. When the input pin is HIGH, negative output pin is LOW and positive output pin is HIGH.

●Absolute maximum ratings (Ta=25°C)

Parameter	Symbol	Limits	Unit
Power supply voltage	Vcc	18	V
Power dissipation	Pd	1.7*1	W
Operating temperature	Topr	-35~85	°C
Storage temperature	Tstg	-55~150	°C

*1 When mounted to a 50 mm × 50 mm × 1.0 mm paper phenol board.
Reduced by 13.6 mW for each increase in Ta of 1°C over 25°C.

●Recommended operating conditions

Parameter	Symbol	Limits	Unit
Power supply voltage	Vcc	6.0~9.0*2	V

*2. 4.5-9 V when regulator not used (pins 5 and 6 may be opened)

● Electrical characteristics (Unless otherwise noted, Ta=25°C, Vcc=8V, f=1kHz, RL=8Ω)

Parameter	Symbol	Min.	Typ.	Max.	Unit	Conditions	Measurement Circuit
Quiescent current	I _{CC}	—	9.0	12.0	mA	No load	Fig. 1
Output voltage, offset	V _{OO}	-50	—	50	mV		Fig. 1
Maximum output amplitude	V _{OM}	5.0	5.4	—	V		Fig. 1
Voltage gain (closed circuit)	G _{VC}	10.5	12.0	13.5	dB	V _{in} =0.1Vrms, 1kHz	Fig. 1
Ripple rejection	RR	—	60	—	dB	V _{in} =0.1Vrms, 100Hz	Fig. 1
Slew rate	SR	—	2.0	—	V/μS	100 kHz square wave, 3 Vp-p output	Fig. 1
Mute On voltage	V _{MON}	—	—	0.5	V		Fig. 1
Mute Off voltage	V _{MOFF}	2.0	—	—	V		Fig. 1
< 5 V regulator >							
Output voltage	V _{REG}	4.75	5.00	5.25	V	I _L =100mA	Fig. 1
Output load variation	ΔV _{RL}	-50	0	10	mV	I _L =0~200mA	Fig. 1
Supply voltage variation	ΔV _{VCC}	-10	0	25	mV	(V _{CC} =6~9V) I _L =100mA	Fig. 1
< Operational amplifier >							
Offset voltage	V _{OPOP}	-5	0	5	mV		Fig. 1
Input bias current	V _{BOP}	—	—	300	nA		Fig. 1
High-level output voltage	V _{OHP}	6.0	—	—	V		Fig. 1
Low-level output voltage	V _{OLP}	—	—	1.8*	V	BA6790FP	Fig. 1
Output drive current (sink)	V _{SINK}	10	50	—	mA	V _{CC} at 50Ω	Fig. 1
Output drive current (source)	I _{SOURCE}	10	40	—	mA	50Ω at ground	Fig. 1
Voltage gain (open loop)	G _{VO}	—	78	—	dB	V _{in} =-75dBV, 1kHz	Fig. 1
Slew rate	SR _{OP}	—	1	—	V/μS	100 kHz square wave, 4 Vp-p output	Fig. 1
Ripple rejection	RR _{OP}	—	65	—	dB	V _{in} =-20dBV, 100Hz	Fig. 1
Common mode rejection ratio	CMRR	—	84	—	dB	V _{in} =-20dBV, 1kHz	Fig. 1

* Low-level output voltage (V_{olop}) of BA6791FP = 1.1 V

● Measurement circuit

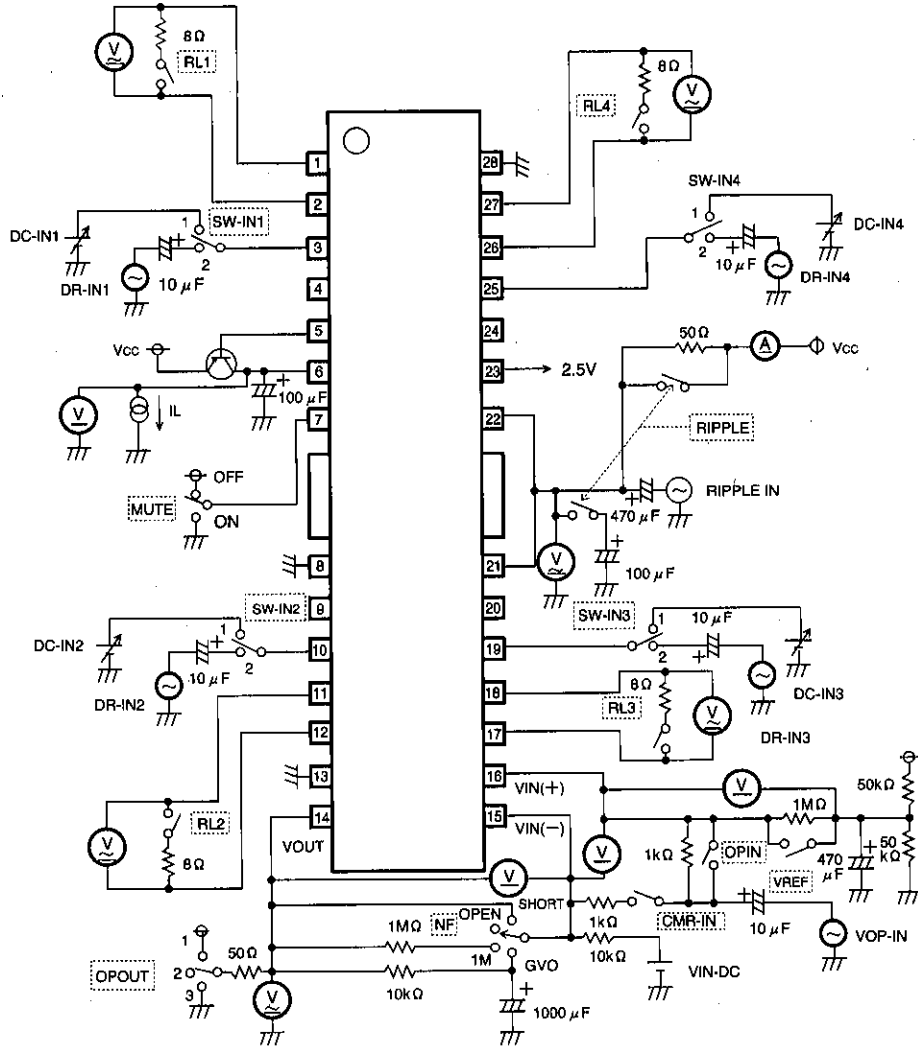

Fig.1

CD/CD-ROM Drivers (4 channels)

For CDs/CD-ROMs

● Measurement circuit switch table

Parameter	Switch										Input				Condition
	RIPPLE	MUTE	RL	OPIN	VREF	CMR-IN	NF	OPOUT	SW-IN	DR-IN	DC-IN	RIPPLEIN	VOPIN	VINDC	
Quiescent current	ON	OFF	OFF	ON	ON	OFF	SHORT	2	2	0	0	0	0	OFF	
Output offset voltage	↓	↓	ON	↓	↓	↓	↓	↓	1	↓	2.5V	↓	↓	↓	
Maximum output amplitude	↓	↓	↓	↓	↓	↓	↓	↓	↓	↓	0V,5V	↓	↓	↓	Only one channel on at a time
Closed loop voltage gain	↓	↓	↓	↓	↓	↓	↓	↓	2	0.1Vrms	0	↓	↓	↓	
Ripple rejection	OFF	↓	↓	↓	↓	↓	↓	↓	1	0	2.5V	0.1Vrms	↓	↓	
Slew rate	ON	↓	↓	↓	↓	↓	↓	↓	2	□	0	0	↓	↓	
Output voltage	↓	↓	OFF	↓	↓	↓	↓	↓	↓	0	↓	↓	↓	↓	
Output load variation	↓	↓	↓	↓	↓	↓	↓	↓	↓	↓	↓	↓	↓	↓	
Supply voltage variation	↓	↓	↓	↓	↓	↓	↓	↓	↓	↓	↓	↓	↓	↓	
Offset voltage	↓	↓	↓	↓	↓	↓	↓	↓	↓	↓	↓	↓	↓	↓	
Input bias current	↓	↓	↓	↓	OFF	↓	1M	↓	↓	↓	↓	↓	↓	↓	
High level output voltage	↓	↓	↓	↓	ON	↓	OPEN	↓	↓	↓	↓	↓	↓	↓	2V
Low level output voltage	↓	↓	↓	↓	↓	↓	↓	↓	↓	↓	↓	↓	↓	↓	6V
Output driver current (sink)	↓	↓	↓	↓	↓	↓	SHORT	1	↓	↓	↓	↓	↓	↓	OFF
Output driver current (source)	↓	↓	↓	↓	↓	↓	↓	3	↓	↓	↓	↓	↓	↓	
Voltage gain (open loop)	↓	↓	↓	↓	↓	↓	GVO	↓	↓	↓	↓	↓	↓	-75dBV	↓
Slew rate	↓	↓	↓	↓	↓	↓	SHORT	↓	↓	↓	↓	↓	↓	□	↓
Ripple rejection	OFF	↓	↓	↓	↓	↓	↓	↓	↓	↓	↓	0.1Vrms	0	↓	
Common mode rejection ratio	ON	↓	↓	OFF	OFF	ON	1M	↓	↓	↓	↓	0	0.1Vrm	↓	

● Input/output circuits

Driver input

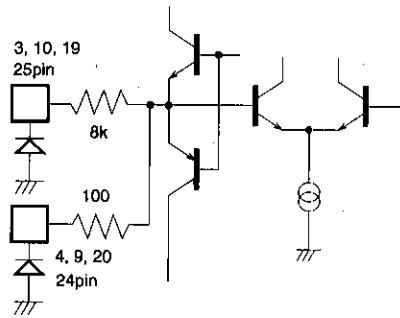

Bias

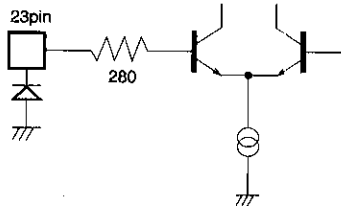

Driver output

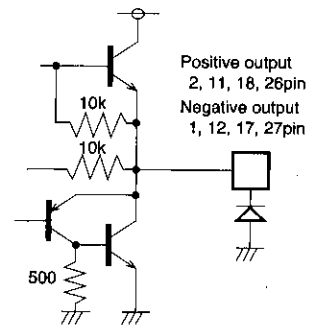

Regulator (base connection)

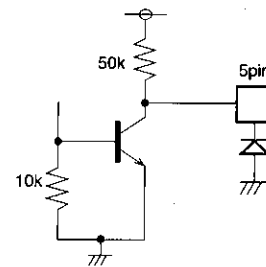

Mute

Regulator output

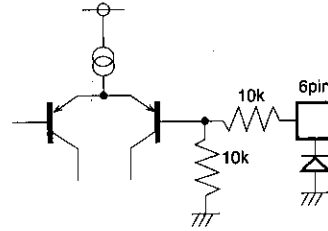
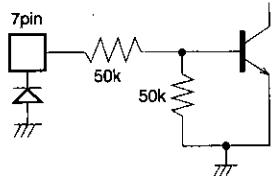

Operational amplifier input

Operational amplifier output

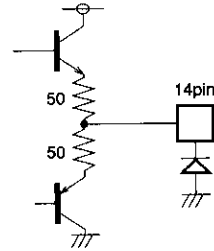
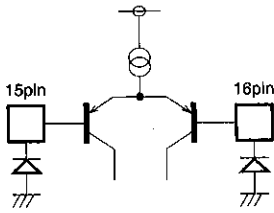

Fig. 2

● Application example

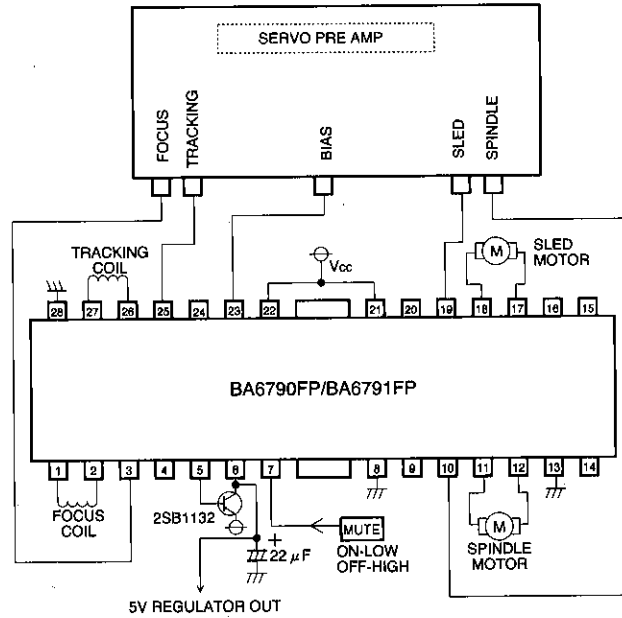
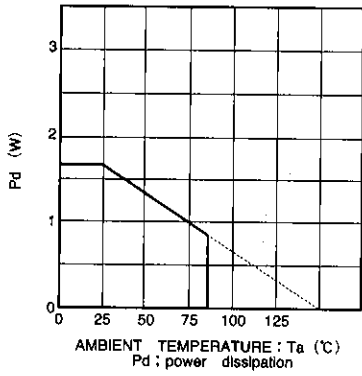

Fig. 3

CD/CD-ROM Drivers (4 channels)

For CDs/CD-ROMs

● Thermal reduction curve



When mounted to a 50 mm X 50 mm X 1.6 mm board
 Fig. 4 Thermal derating curve

● Operation notes

1. The BA6790FP and BA6791FP have an internal thermal shutdown circuit. Output current is muted when the chip temperature exceeds 175°C (typically) and restored when the chip temperature falls to 150°C (typically).
2. If the mute pin (7 pin) voltage is opened or lowered below 0.5V, the output current will be muted. Pin 7 should be pulled up above 2.0V during normal use.
3. The bias pin (23 pin) is muted when lowered below 1.4V (typically). Make sure it stays above 1.6V during normal use.
4. Muting occurs during thermal shutdown, mute-on operations or a drop in the bias pin voltage. In each case, only the drivers are muted. During muting, the output pins remain at the internal bias voltage, roughly $(V_{CC}/2)$.
5. Be sure to connect the IC to a 0.1 μ F bypass capacitor to the power supply, at the base of the IC.
6. The radiating fin is connected to the package's internal GND, but should also be connected to an external ground.
7. The capacitor between regulator output (6 pin) and GND also serves to prevent oscillation of the IC, so select one with good temperature characteristics.

● External dimensions (Units: mm)

