

FM front end

BA4402 / BA4404

The BA4402 and BA4404 are front end ICs for FM radio receivers. These devices can be used in a wide range of applications, from 3V portable radios to home stereo tuners.

The BA4402 and BA4404 consist of an RF amplifier, oscillator circuit, mixer circuit, and a variable capacitor-diode for AFC. They are pin compatible, and either can be selected depending on the amount of gain needed and other requirements of the application.

●Applications

- FM pocket radios
- Radio cassette players
- Home stereos

●Features

- 1) Wide operating voltage range : 1.8 to 9V.
- 2) High gain with good stability.
- 3) An appropriate device can be selected depending on the need for AFC and the amount of gain required.

●Block diagram

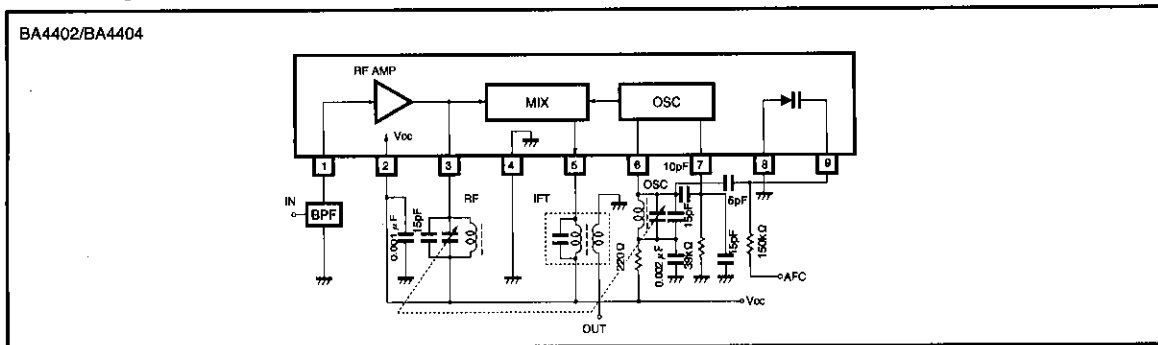

Product name	Variable capacitor	Gain	RF amplifier
BA4402	Yes	32dB	Common base
BA4404	Yes	38dB	Common emitter

● Absolute maximum ratings (Ta = 25°C)

Parameter	Symbol	Limits	Unit
Supply voltage	V _{CC}	9	V
Power dissipation	P _d	1000*1	mW
Operating temperature	T _{opr}	-25~75	°C
Storage temperature	T _{stg}	-55~125	°C

* 1 At temperatures above Ta = 25°C, decreases 10 mW per degree.

● Electrical characteristics (unless otherwise indicated, Ta = 25°C and V_{CC} = 3V)

BA4402

Parameter	Symbol	Min.	Typ.	Max.	Unit	Conditions	Measurement Circuit
Quiescent current	I _Q	—	2.5	4.0	mA	—	Fig.1
Output voltage 1	V _{O1}	25	40	55	mV	f _{IN} =100MHz, 60dB μV	Fig.1
Output voltage 2	V _{O2}	80	120	160	mV	f _{IN} =100MHz, 100dB μV	Fig.1
Oscillator voltage	V _{OSC}	180	250	340	mV	V _{CC} =2V	Fig.1
Oscillation stop voltage	V _{STOP}	—	1.4	1.6	V	—	Fig.1

BA4404

Parameter	Symbol	Min.	Typ.	Max.	Unit	Conditions	Measurement Circuit
Quiescent current	I _Q	—	3.0	5.0	mA	—	Fig.1
Output voltage 1	V _{O1}	55	80	120	mV	f _{IN} =100MHz, 60dB μV	Fig.1
Output voltage 2	V _{O2}	80	120	160	mV	f _{IN} =100MHz, 100dB μV	Fig.1
Oscillator voltage	V _{OSC}	180	250	340	mV	V _{CC} =2V	Fig.1
Oscillation stop voltage	V _{STOP}	—	1.4	1.6	V	—	Fig.1

Front end

High-frequency signal processors

● Measurement circuit

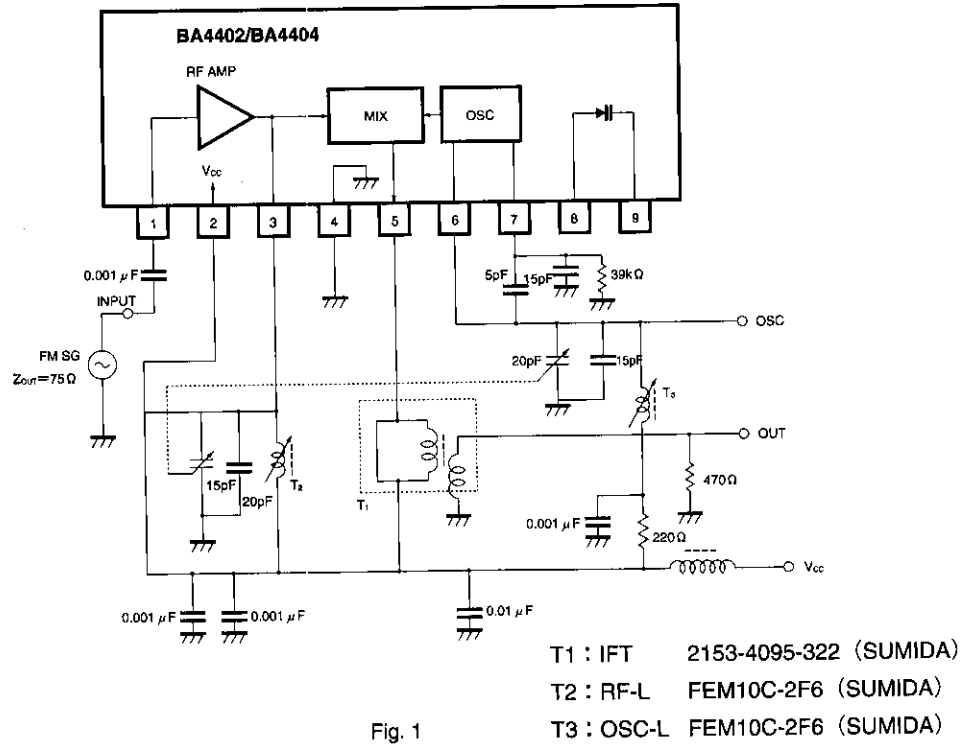

Fig. 1

● Application example

BA4402/BA4404

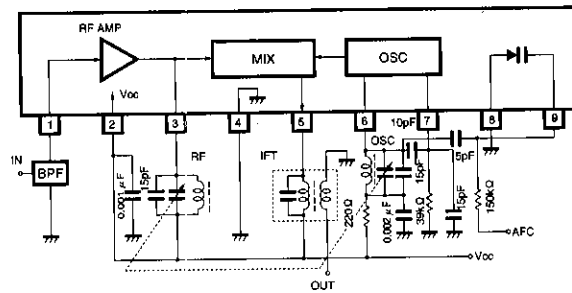

Fig. 2

●Electrical characteristic curves

BA4402

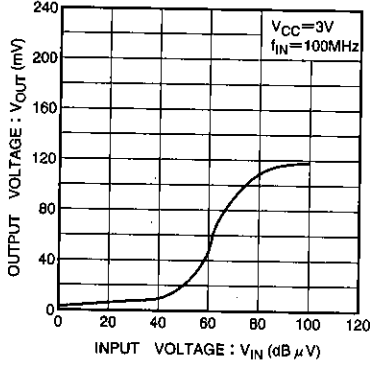

Fig. 3 Output voltage vs. input voltage

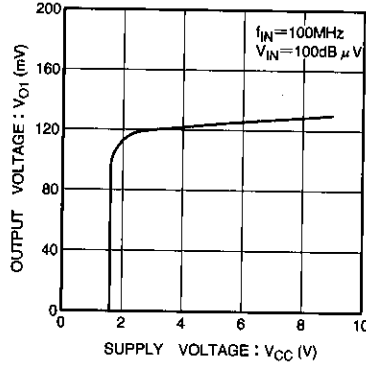

Fig. 4 Output voltage 1 vs. supply voltage

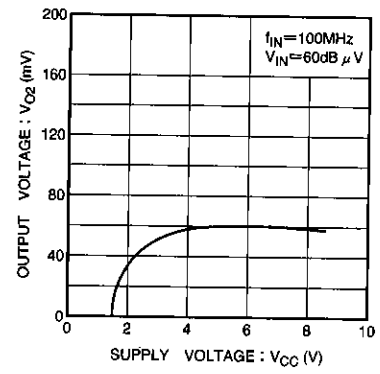

Fig. 5 Output voltage 2 vs. supply voltage

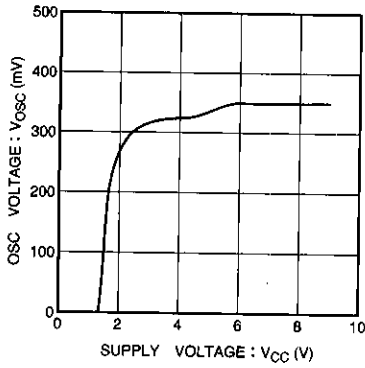

Fig. 6 Oscillator voltage vs. supply voltage

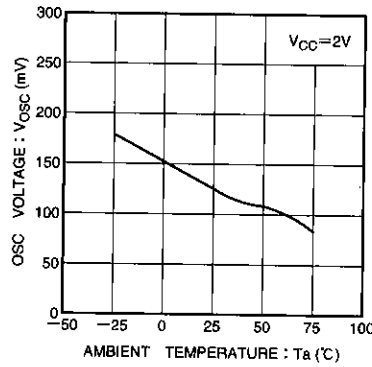

Fig. 7 Oscillator voltage vs. ambient temperature

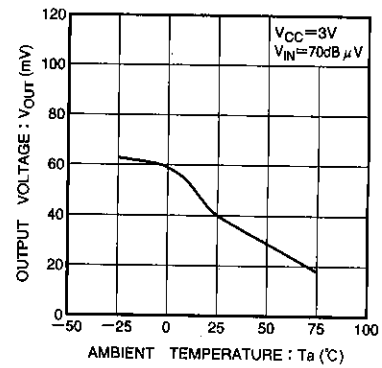

Fig. 8 Output voltage vs. ambient temperature

BA4404

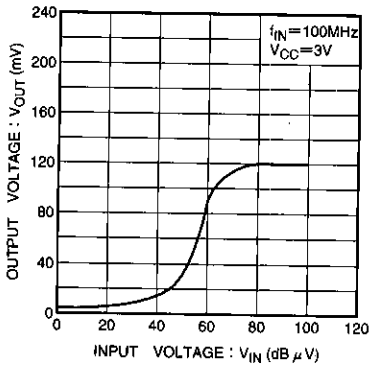

Fig. 9 Output voltage vs. input voltage

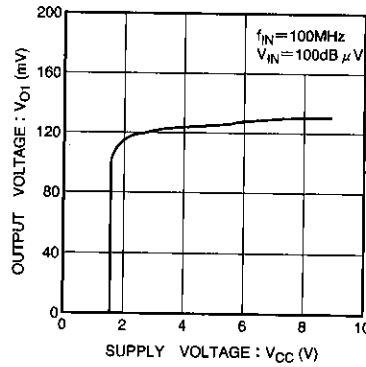

Fig. 10 Output voltage 1 vs. supply voltage

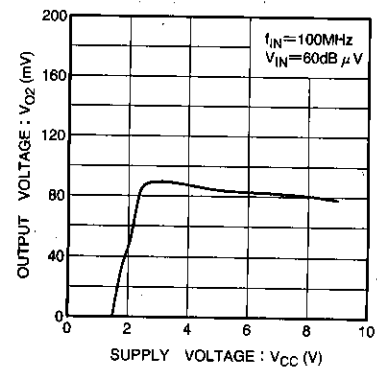

Fig. 11 Output voltage 2 vs. supply voltage

Front end

High-frequency signal processors

BA4404

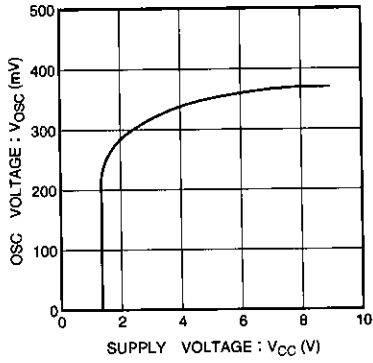

Fig. 12 Oscillator voltage vs. supply voltage

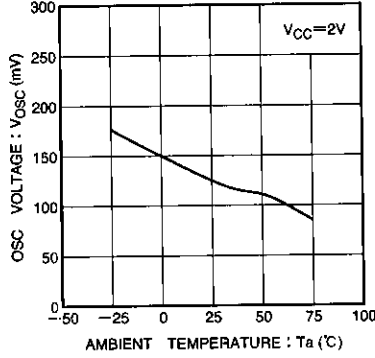

Fig. 13 Oscillator voltage vs. ambient temperature

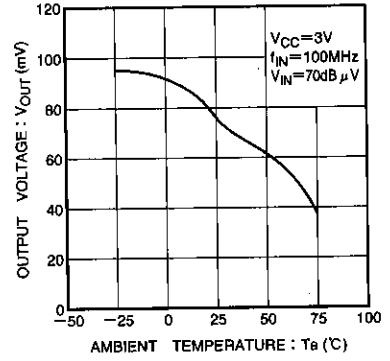

Fig. 14 Output voltage vs. ambient temperature

BA4402/BA4404

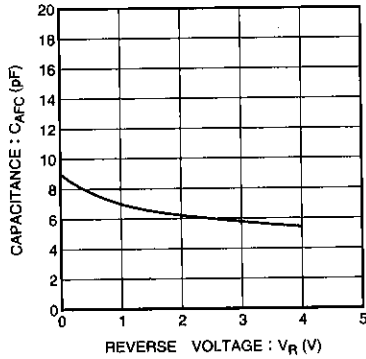

Fig. 15 AFC capacitor capacitance vs. applied voltage

● External dimensions (Unit: mm)

