

# System power supply for CD radio cassette players

## BA3936

The BA3936 is a system power supply for use in CD radio cassette players. With two 8V outputs, two 5V outputs, one 7.8V output, one POWER CONTROL output, the IC is best suited for CD radio cassette players.

### ●Applications

CD radio cassette players

### ●Features

- 1) Two 8V outputs, two 5V outputs, one 7.8V output, and a POWER CONTROL output are built in.
- 2) Precise output voltage is obtained by using external reference voltage input (only AUDIO 8V and LIMIT 7.8V outputs have an internal reference voltage system).
- 3) Output current limit circuit protects the IC against short-circuiting damage.
- 4) Compact SIP-M12 package allows a large power dissipation.

### ●Absolute maximum ratings (Ta = 25°C)

Parameter	Symbol	Limits	Unit
Power supply voltage	VCC	23	V
Power dissipation	Pd	3000	mW
Operating temperature	Topr	-25~75	°C
Storage temperature	Tstg	-55~150	°C

\* Reduce power 24mW for each degree above 25°C.

### ●Recommended operating conditions (Ta = 25°C)

Parameter	Symbol	Min.	Typ.	Max.	Unit
Power supply voltage	Vcc	6.5	—	22	V

●Block diagram

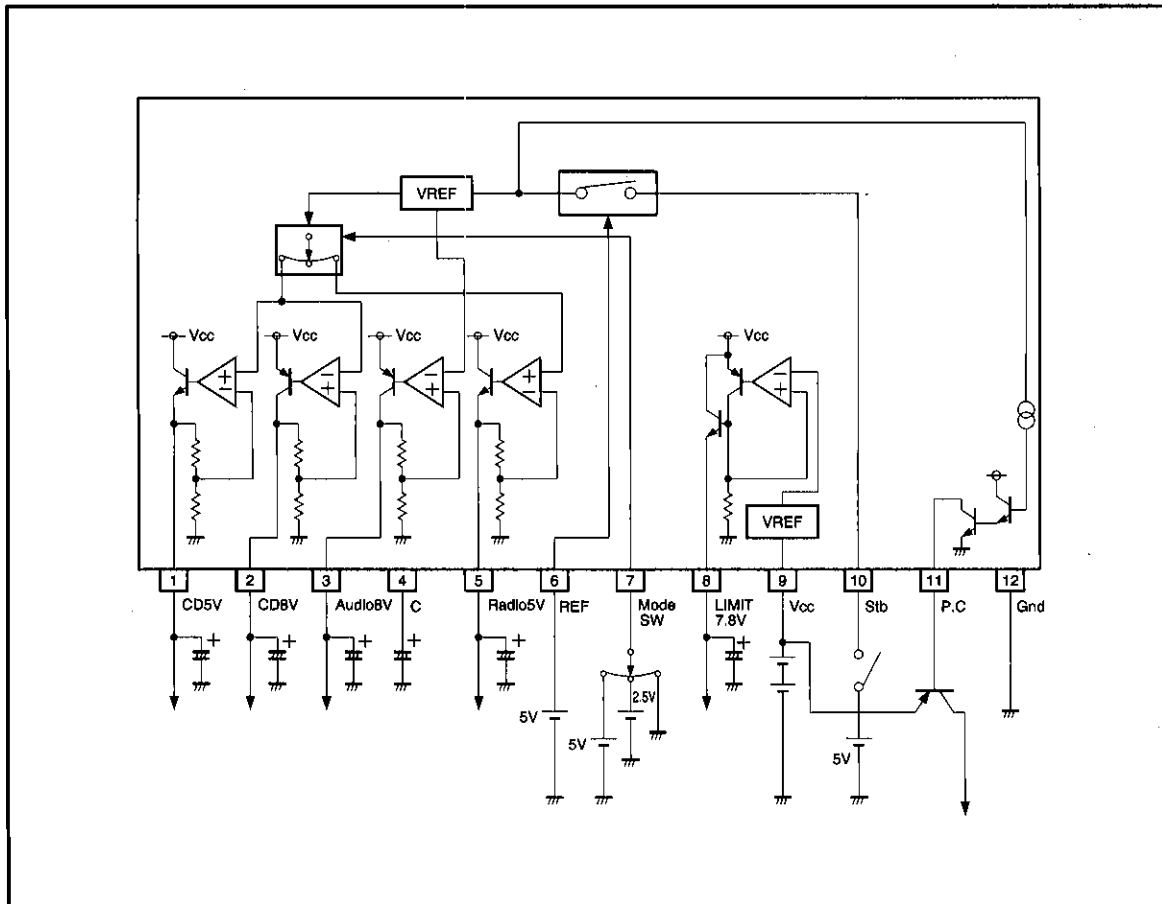

● Input/output circuits

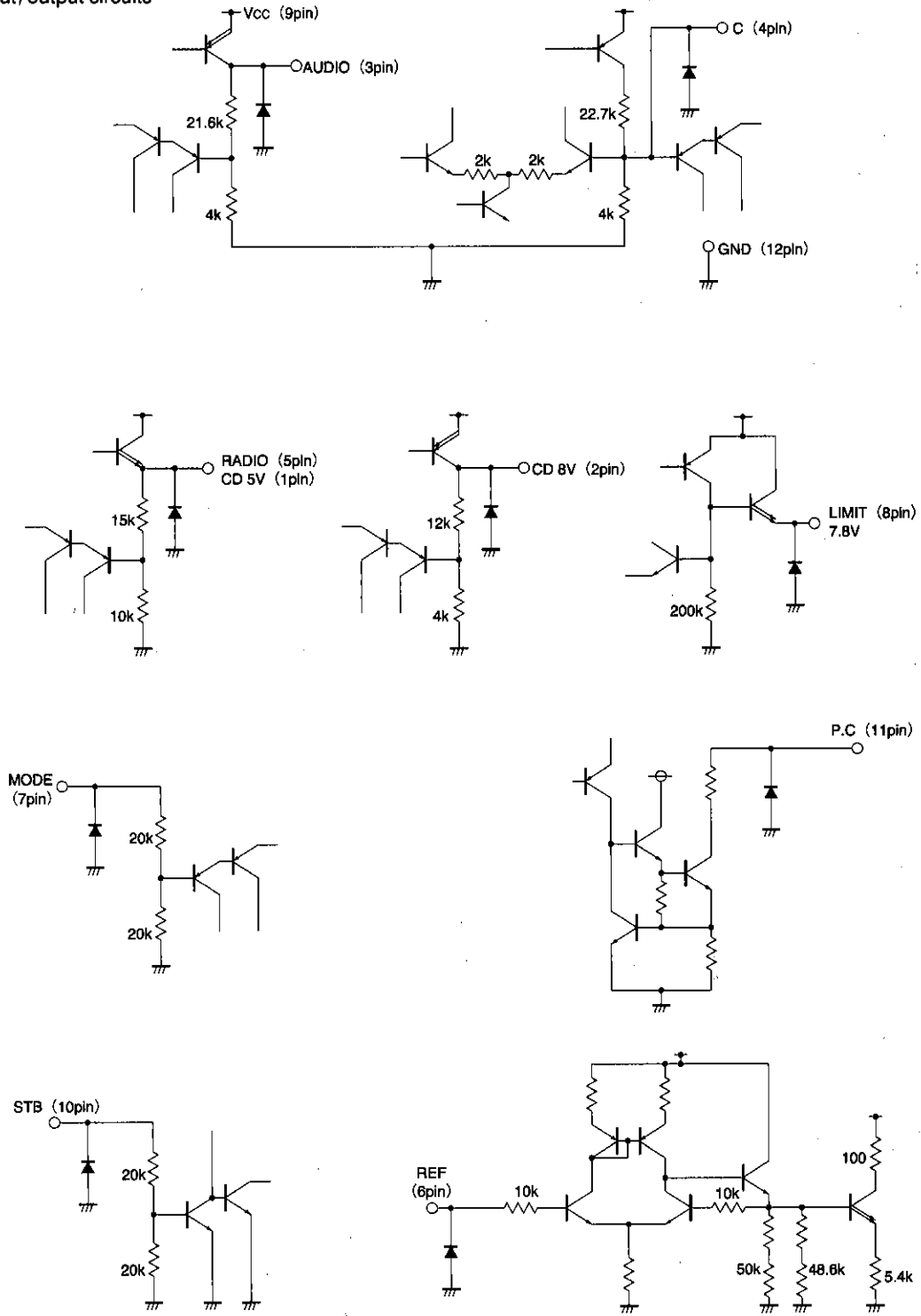

BA392X/3X/4X/5X/6X Series

System Power Supply

●Electrical characteristics (unless otherwise noted, Ta=25°C, Vcc=12.0V, and REF=5V)

Parameter	Symbol	Min.	Typ.	Max.	Unit	Conditions
Standby circuit current	Ist	--	320	450	μA	STB, MODE=0V
Output voltage (7.8V Limit)	Vo1	7.3	7.8	8.3	V	Io1=50mA
Voltage variation	ΔVo11	--	70	200	mV	Vcc=10V~22V, Io1=50mA
Load variation	ΔVo12	--	250	400	mV	Io1=10μA~50mA
Minimum I/O voltage differential	ΔVo13	--	1.0	1.2	V	Io1=50mA
Output current capacity	Io1	60	110	—	mA	Vo≥7.3V
Ripple rejection ratio	R.R1	32	42	—	dB	f=100Hz VRR=-10dBV
Output reverse current	Iin1	--	0	10	μA	Vcc - GND SHORT, Output = 7V applied
Output voltage (AUDIO 8.0V)	Vo2	7.5	8.0	8.5	V	Io2=250mA
Voltage variation	ΔVo21	--	40	200	mV	Vcc=10V~22V, Io2=250mA
Load variation	ΔVo22	--	60	200	mV	Io2=0mA~250mA
Minimum I/O voltage differential	ΔVo23	--	0.55	1.0	V	Io2=250mA
Output current capacity	Io2	300	550	—	mA	Vo≥7.5V
Ripple rejection ratio	R.R2	50	54	—	dB	f=100Hz VRR=-10dBV
Output voltage (CD 8V)	Vo3	7.5	8.0	8.5	V	Io3=400mA
Voltage variation	ΔVo31	--	40	200	mV	Vcc=10V~22V, Io3=400mA
Load variation	ΔVo32	--	70	250	mV	Io3=0mA~400mA
Minimum I/O voltage differential	ΔVo33	--	0.4	1.0	V	Io3=400mA
Output current capacity	Io3	0.8	1.2	—	A	Vo≥7.5V
Ripple rejection ratio	R.R3	40	50	—	dB	f=100Hz VRR=-10dBV
Output voltage (CD 5V)	Vo4	4.9	5.0	5.1	V	Io4=180mA
Voltage variation	ΔVo41	--	20	200	mV	Vcc=6.5V~22V, Io4=180mA
Load variation	ΔVo42	--	20	200	mV	Io4=0mA~180mA
Minimum I/O voltage differential	ΔVo43	--	1.0	1.5	V	Io4=180mA
Output current capacity	Io4	220	350	—	mA	Vo≥4.9V
Ripple rejection ratio	R.R4	50	60	—	dB	f=100Hz VRR=-10dBV
Output voltage (RADIO 5V)	Vo5	4.9	5.0	5.1	V	Io5=80mA
Voltage variation	ΔVo51	--	20	200	mV	Vcc=6.5V~22V, Io5=80mA
Load variation	ΔVo52	--	20	200	mV	Io5=0mA~80mA
Minimum I/O voltage differential	ΔVo53	--	0.8	1.5	V	Io5=80mA
Output current capacity	Io5	100	200	—	mA	Vo≥4.9V
Ripple rejection ratio	R.R5	50	57	—	dB	f=100Hz VRR=-10dBV

Parameter	Symbol	Min.	Typ.	Max.	Unit	Conditions
POWER CONTROL voltage, LOW	Vp.c.	0.2	0.5	0.8	V	When Ip.c.=5mA
POWER CONTROL current	Ip.c.	10	20	—	mA	
Input (MODE SW)						
Voltage when RADIO MODE ON	VRaon	1.1	1.4	1.7	V	RADIO output voltage when ON
Voltage when RADIO MODE OFF	VRaoff	2.9	3.2	3.5	V	RADIO output voltage when OFF
Voltage when CD MODE ON	VCDon	2.9	3.2	3.5	V	CD5V, CD8.0V output voltage when switched to HIGH
Input current when HIGH	IMODE	80	110	140	$\mu$ A	MODE=5V
Input (REF STB)						
Input current when HIGH	IREF	—	0	10	$\mu$ A	STB=5V
Input (STB)						
Standby switching voltage	VST	1.1	1.4	1.7	V	
Input current when HIGH	ISTB	140	215	290	$\mu$ A	STB=5V

© Not designed to be radiation resistance.

●Circuit operation

LIMIT 7.8V rises regardless of VREF, STB, and MODE SW.

AUDIO 8V and POWER CONTROL rises when STB is HIGH, regardless of MODE SW (VREF 5V is also required for POWER CONTROL).

RADIO 5V rises when MODE SW is 1.4V (typical), and CD 5V and CD 8V rise when MODE SW is 3.2V (typical).

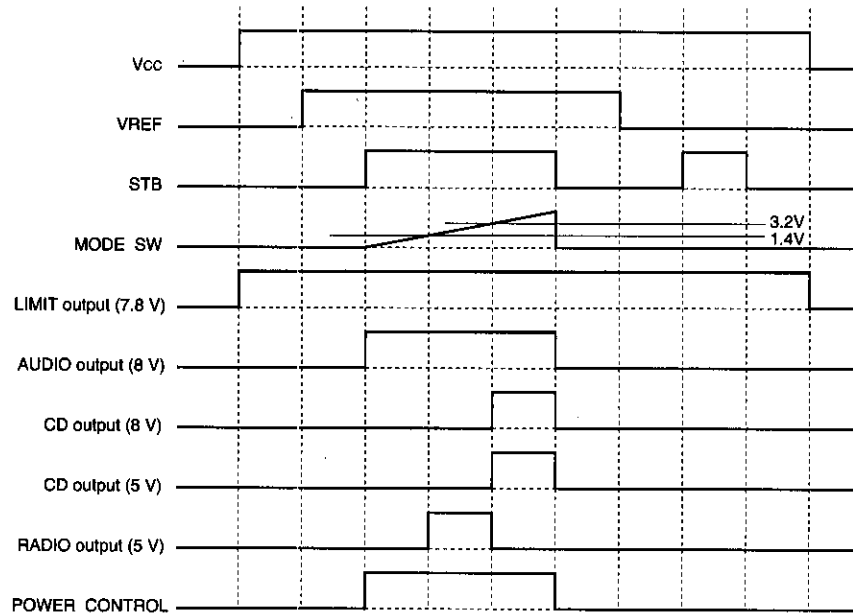

Fig.1 Timing chart

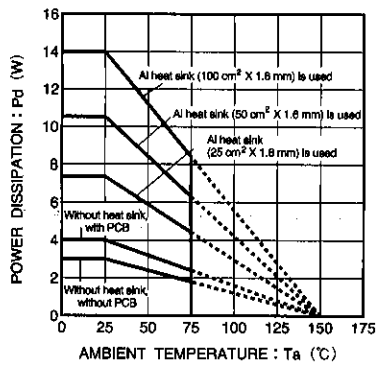

Fig.5 Thermal derating curves

● Rough estimation of IC power dissipation

Except under transitional conditions, the power dissipation of this IC is 3W per unit at 25°C. See Fig. 5 for heat reduction characteristics, including some cases where heat sinks are used.

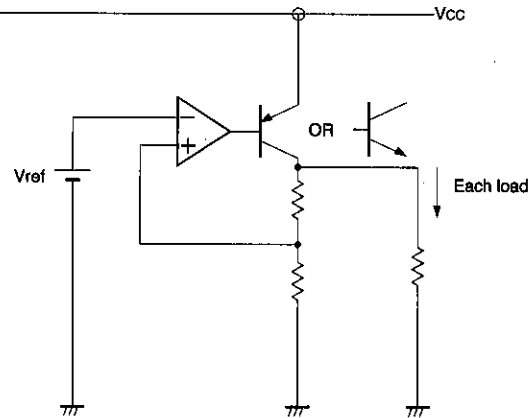

Fig.3

- Power consumed by LIMIT 7.8V  $P_1 = (V_{CC} - 7.8V) \times \text{maximum output current of LIMIT 7.8V}$
  - Power consumed by AUDIO 8.0V  $P_2 = (V_{CC} - 8.0V) \times \text{maximum output current of AUDIO 8.0V}$
  - Power consumed by CD 8.0V  $P_3 = (V_{CC} - 8.0V) \times \text{maximum output current of CD 8.0V}$
  - Power consumed by CD 5.0V  $P_4 = (V_{CC} - 5.0V) \times \text{maximum output current of CD 5.0V}$
  - Power consumed by RADIO 5.0V  $P_5 = (V_{CC} - 5.0V) \times \text{maximum output current of RADIO 5.0V}$
  - Power consumed internally by each circuit  $P_6 = V_{CC} \times \text{circuit current}$
- $P_{MAX.} = P_1 + P_2 + (P_3 + P_4 \text{ or } P_5, \text{ whichever is greater}) + P_6$

## ● Application example

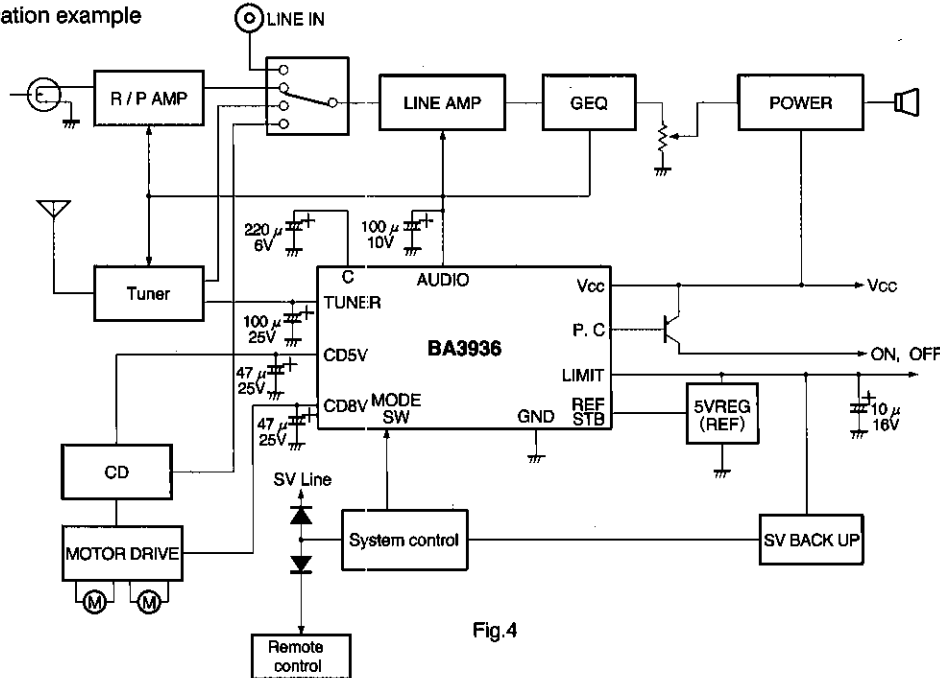

Fig.4

## ● Precautions for use

## 1. Operating power supply

When operating within proper ranges of power supply voltage and ambient temperature, most circuit functions are guaranteed. Although the rated values of electrical characteristics cannot be absolutely guaranteed, characteristic values do not change drastically within the proper ranges.

## 2. Power dissipation (Pd)

Refer to the heat reduction characteristics (Fig. 5) and the rough estimation of IC power dissipation given on a separate page. Make sure to use the IC within the allowable power dissipation with a sufficient margin.

## 3. Preventing oscillation at each output and installing a ripple filter capacitor

To stop oscillation of output, make sure to connect a capacitor between GND and each of the AUDIO 8V (pin 3), RADIO (pin 5), CD 5V (pin 1), CD 8V (pin 2), and LIMIT 7.8V (pin 8) output pins. We recommend using a tantalum electrolytic capacitor having a capacitance of 10  $\mu$ F or greater (100  $\mu$ F or greater for AUDIO 8V) with minimal temperature susceptibility. A minimum capacitance value recommended for each electrolytic capacitor is shown

in the application circuit. Also, sudden deterioration of the AUDIO 8V ripple rejection during a power drop can be prevented by connecting a capacitor (220  $\mu$ F or greater recommended) to the C pin (pin 4).

## 4. Overcurrent protection circuit

An overcurrent protection circuit is installed on the AUDIO 8V (pin 3), RADIO (pin 5), CD 5V (pin 1), CD 8V (pin 2), and LIMIT 7.8V (pin 8) outputs, based on the respective output current. This prevents IC destruction by overcurrent, by limiting the current with a curve shape of "7" in the voltage-current graph. The IC is designed with margins so that current flow will be restricted and latching will be prevented even if a large current suddenly flows through a large capacitor. Note that these protection circuits are only good for preventing damage from sudden accidents. Make sure your design does not cause the protection circuit to operate continuously under transitional conditions (for instance, if output is clamped at 1V<sub>F</sub> or higher, short mode circuit operates at 1V<sub>F</sub> or lower).



5. Reference voltage

Because output voltage is dependent on the input reference voltage, unstable input results in output wavering and degradation of ripple rejection. Take care when setting the reference voltage power supply. Note that the AUDIO 8V and LIMIT 7.8V outputs, which have a built-in reference voltage system, are not affected by the external reference voltage.

6. Thermal protection circuit

A built-in thermal protection circuit prevents thermal damage to the IC. All outputs except LIMIT 7.8V are switched OFF when the circuit operates, and revert to the original state when temperature drops to a certain level.

7. Grounding

Each ground line in the application circuit must be adequately short regarding the GND (pin 12) pin. Make sure to arrange the ground lines, the AUDIO system, and other outputs in a pattern that prevents electric interference.

●External dimensions (Units: mm)

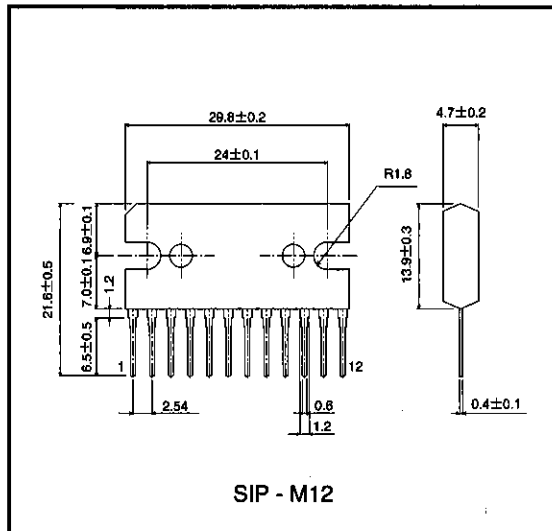

●Electrical characteristic curves

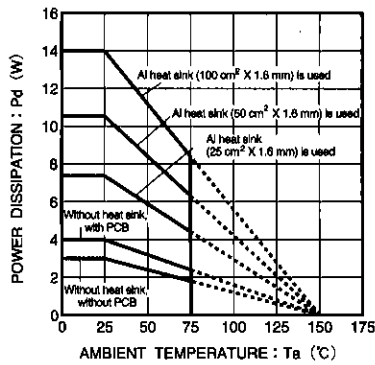

Fig.5 Thermal derating characteristics