

BBS (bass boost system) for radio cassette players

BA3870

The BA3870 is a bass boost audio IC for radio cassette players. BBS adjusts the base boost to a level appropriate for the volume, achieving a rich sound without distortion. Frequency characteristics can be set externally, enabling system design to meet the needs of the application.

● Applications

Radio cassette players

● Features

- 1) Adjustment of the base boost to a level appropriate for the volume through BBS.
- 2) Maximum bass boost level can be set externally. (20dB recommended)
- 3) Treble boost circuit (constant at 4dB) included on-chip to preserve overall balance.
- 4) BBS on/off "pop" sound almost nonexistent.

● Block diagram

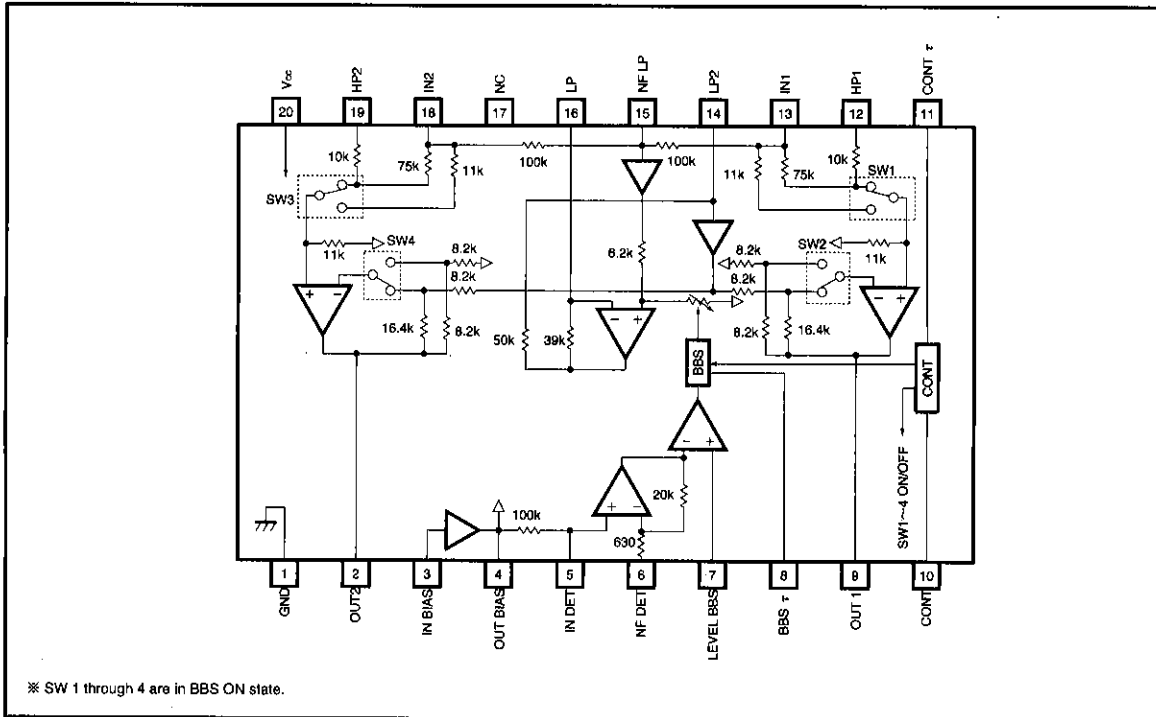

Bass boost systems

Audio accessory components

● Absolute maximum ratings (Ta = 25°C)

Parameter	Symbol	Limits	Unit
Supply voltage	V _{cc}	9.0	V
Power dissipation	P _d	600*	mW
Operating temperature	T _{opr}	-25~75	°C
Storage temperature	T _{stg}	-55~125	°C

* When used above Ta = 25°C, decreases 6.0 mW per degree.

● Recommended operating conditions (Ta = 25°C)

Parameter	Symbol	Limits	Unit
Supply voltage	V _{cc}	3.0~7.0	V

● Pin description

Pin No.	Pin name	Function
1	GND	Substrate ground
2	OUT2	Output 2
3	BIAS IN	Bias amplifier input
4	BIAS OUT	Bias amplifier output
5	DET IN	Detection amplifier positive input
6	DET NF	Detection amplifier negative input
7	BBS LEVEL	BBS level setting
8	BBS τ	BBS time constant setting
9	OUT1	Output 1
10	CONT	BBS on/off switch
11	CONT τ	BBS time constant setting
12	HP 1	High-range input
13	IN 1	Input 1
14	LP 2	Low-range amplifier output
15	LP 1	Low range amplifier positive input
16	LP NF	Low range amplifier negative input
17	NC	Not connected to inside of IC
18	IN 2	Input 2
19	HP 2	High-range input 2
20	V _{cc}	Voltage supply

● Input/output circuit

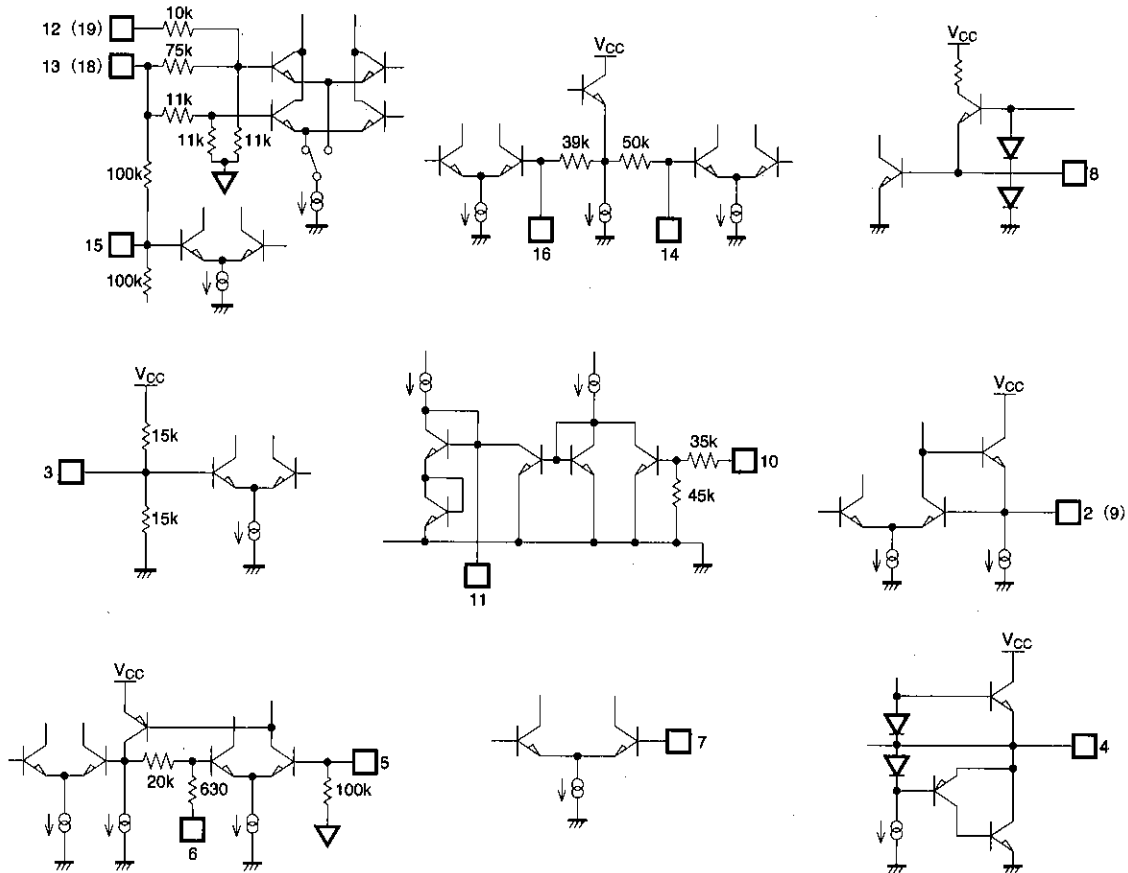

● Electrical characteristics (unless otherwise indicated, $T_a = 25^\circ\text{C}$, $V_{CC} = 5.0\text{V}$, and $f = 1\text{kHz}$)

Parameter	Symbol	Min.	Typ.	Max.	Unit	Condition
Quiescent circuit current	I_Q	—	5.0	8.0	mA	BBS ON
voltage gain	G_V	-2.5	0	+2.5	dB	BBS OFF
Total harmonic distortion	THD	—	0.05	0.2	%	BBS ON, $V_o=20\text{dBm}$, DET IN=0Vrms
Output noise voltage	V_{NO}	—	-90	-84	dBm	BBS ON, DIN AUDIO, $R_g=2.2\text{k}\Omega$
Input resistance	R_{IN}	9	13.5	18	$\text{k}\Omega$	
Channel separation	CS	—	-58	-53	dB	BBS OFF, $V_o=0\text{dBm}$, $R_g=2.2\text{k}\Omega$
Bass boost	BB	17	20	23	dB	$V_{IN}=-50\text{dBm}$, $f=100\text{Hz}$, DET IN=0Vrms
Treble boost	TB	2.0	4.0	6.0	dB	$V_{IN}=-50\text{dBm}$, $f=10\text{kHz}$
Ripple rejection	RR	23	28	—	dB	BBS ON, $V_{RR}=-30\text{dBm}$, $f_{RR}=100\text{Hz}$, $R_g=0\Omega$
HIGH threshold voltage	V_{TH}	—	1.1	1.4	V	
Maximum output voltage	V_{OM}	0.7	1.2	—	Vrms	BBS OFF, THD=1%, $R_L=10\text{k}\Omega$

● Measurement circuit

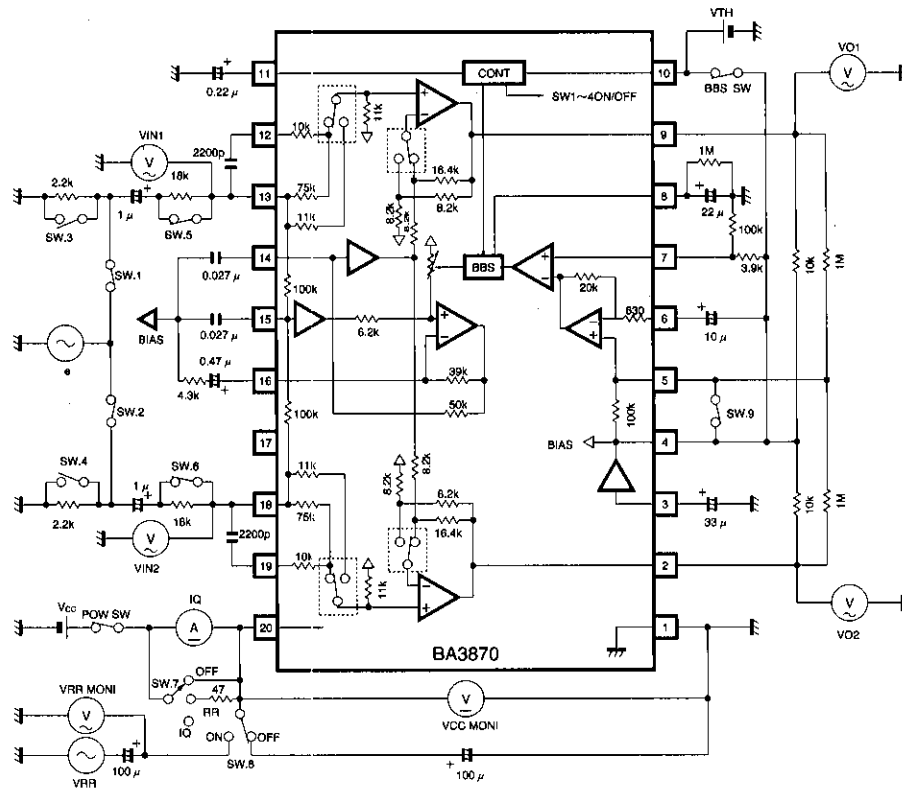

● Circuit Operation

1. Overview of BBS

BBS is a system which boosts the low end of the audible frequency range and at the same time linearly controls the amount of boost according to the volume to produce a rich sound without distortion through small diameter speakers. It also adjusts the gain of the high-frequency range to attain a balanced sound with natural volume.

2. Operation of BBS

2.1 BBS on

The signal system when BBS is on is shown in Fig. 1.

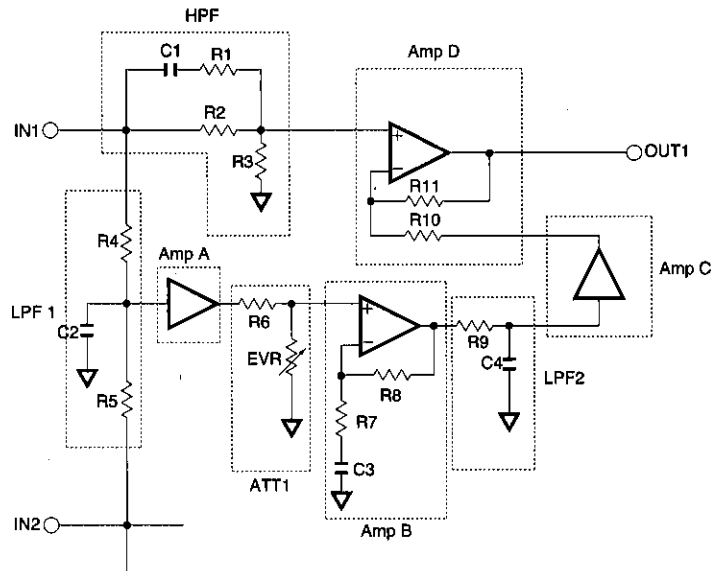

Fig. 1 Signal system when BBS is on.

Bass boost systems

Audio accessory components

2.1.1 Low range signal system

The transmission of low range signals in Fig. 1 is as shown below.

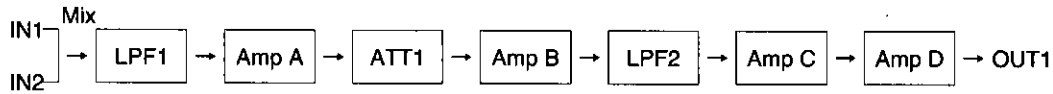

The frequency characteristics of each block are as shown in Fig. 2, and the gain and cutoff frequency of each are given by the following equations.

Cutoff frequency of LPF1 : $f_{CL1} = \frac{1}{2\pi \cdot (R_4 // R_5) \cdot C_2}$ (Hz)

Attenuation of LPF1 : $G_{LP1} = 20 \log \frac{R_5}{R_4 + R_5}$ (dB)

Gain of Amp A : $G_A = 0$ (dB)

Attenuation of ATT1 : $G_{ATT1} = 20 \log \frac{EVR}{R_6 + EVR}$ (dB)

Gain of Amp B : $G_B = 20 \log \frac{R_7 + R_6}{R_7}$ (dB)

Cutoff frequency of Amp B : $f_{CL3} = \frac{1}{2\pi \cdot R_7 \cdot C_3}$ (Hz)

Cutoff frequency of LPF2 : $f_{CL2} = \frac{1}{2\pi \cdot R_9 \cdot C_4}$ (Hz)

Gain of Amp C : $G_C = 0$ (dB)

Gain of Amp D : $G_{DL} = 20 \log \frac{R_{11}}{R_{10}}$ (dB)

Here, $R_4 = R_5 = 2R_9$ and $C_2 = C_4$, thus $f_{CL1} = f_{CL2}$

and the total frequency shows a -12dB/OCT bass boost as indicated in Fig. 3.

Also, as $R_{11} = 2R_{10}$,
 $G_{LP1} + G_{DL} = -6 + 6 = 0$ (dB)

and thus the total gain during EVR Max. is

$$G_{L\text{Max}} = G_{LP1} + G_A + G_B + G_C + G_{DL} = G_B \text{ (dB)}$$

● Circuit operation

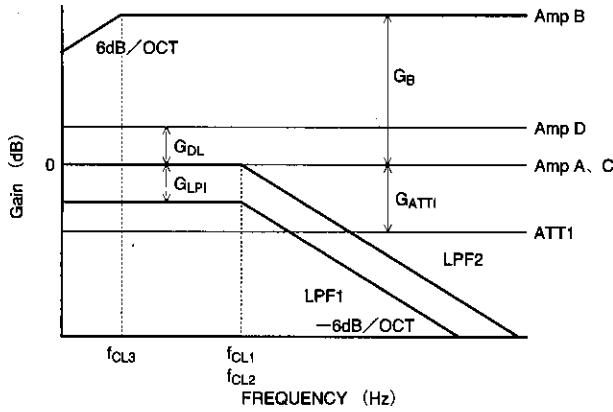

Fig. 2 Frequency characteristics of each block of low-range signal system

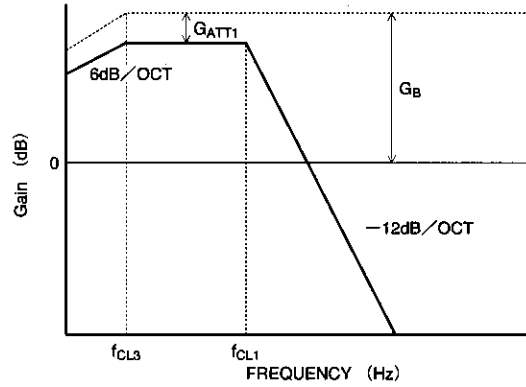
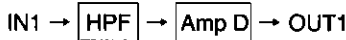

Fig. 3 Total frequency characteristics of low-range signal system

2.1.2 High-range signal system

The transmission of high frequency signals in Fig. 1 is as shown below.



The frequency characteristics of each block are shown in Fig. 4, and the gain and cutoff frequency of each are given by the following equations.

Cutoff frequency 1 of HPF : $f_{CH1} = \frac{1}{2\pi \cdot (R_1 + R_2) C_1}$ (Hz)

Cutoff frequency 2 of HPF : $\frac{(R_2 + R_3)}{2\pi \cdot (R_1 R_2 + R_2 R_3 + R_1 R_3) C_1}$ (Hz)

Attenuation of HPF in frequency range $f < f_{CH1}$: $G_{HP1} = 20 \log \frac{R_3}{R_2 + R_3}$ (dB)

Attenuation of HPF in frequency range $f_{CH2} < f$: $G_{HP2} = 20 \log \frac{R_3}{R_1 // R_2 + R_3}$ (dB)

Gain of Amp D : $G_{DH} = 20 \log \frac{R_{10} + R_{11}}{R_{10}}$ (dB)

The total frequency characteristics show a +6dB/OCT treble boost as shown in Fig. 5.

Also, $R_{11} = 2R_{10}$, thus

$G_{DH} = +9.5$ (dB)

and the total gain G_{H1} in the $f < f_{CH1}$ frequency range is

$G_{H1} = G_{HP1} + G_{DH}$
 $= G_{HP1} + 9.5$ (dB)

The total gain G_{H2} in the $f_{CH2} < f$ frequency range is

$G_{H2} = G_{HP2} + G_{DH}$
 $= G_{HP2} + 9.5$ (dB)

2.1.3 Combination of frequency characteristics

By combining the low-range characteristics (Fig. 3) and the high-range characteristics (Fig. 5), ideal BBS characteristics can be obtained as shown in Fig. 6.

Bass boost systems

Audio accessory components

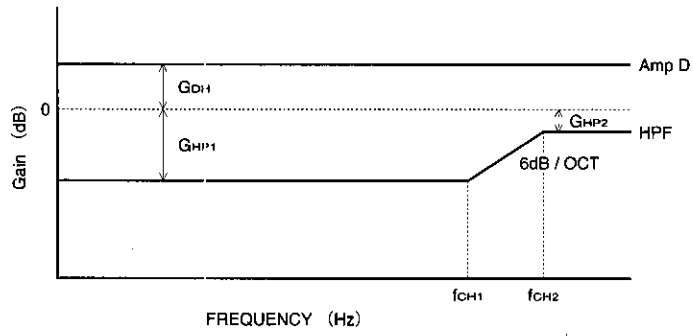

Fig. 4 Frequency characteristics of each block of high-range signal system

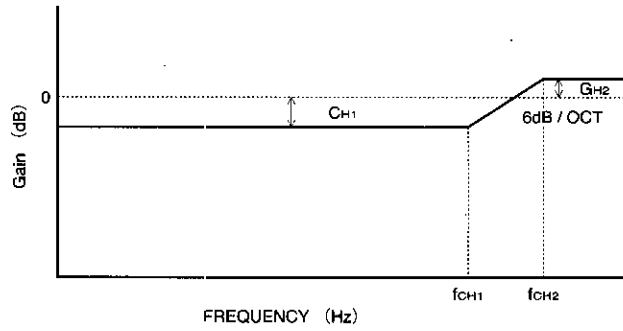

Fig. 5 Total frequency characteristics of high-range signal system

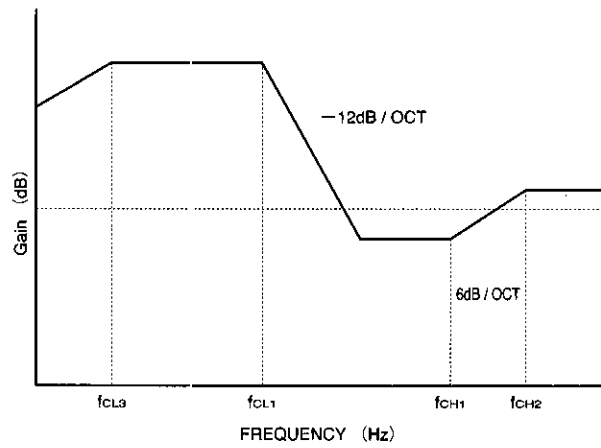

Fig. 6 Total frequency characteristics when BBS is on

● Circuit operation

2.1.4 Bass boost control system

Bass boost control is as follows in Fig. 7.

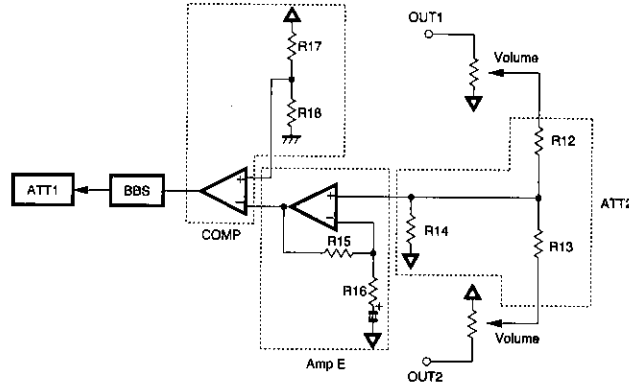
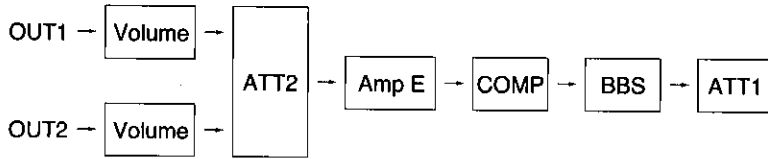

Fig. 7 Bass boost control system

The comparator level and gain of each block are given by the following equations.

Attenuation of ATT2 :

$$: G_{ATT2} = 20 \log \frac{R_{13} // R_{14}}{R_{12} + R_{13} // R_{14}} \quad (\text{dB})$$

Gain of Amp E :

$$: G_E = 20 \log \frac{R_{15} + R_{16}}{R_{16}} \quad (\text{dB})$$

Comparator level of COMP :

$$: V_{COM} = 20 \log \left(\frac{V_B}{\sqrt{2}} \cdot \frac{R_{17}}{R_{17} + R_{18}} \right) \quad (\text{dBV})$$

V_B : DC voltage at BIAS OUT pin

If the volume output level at the beginning of control of the low range signal system ATT1 is V_{BBS} (dBV),

$$V_{BBS} + G_{ATT2} + G_E = V_{COM}$$

In this way, bass boost control is carried out based on the volume as shown in Fig. 8.

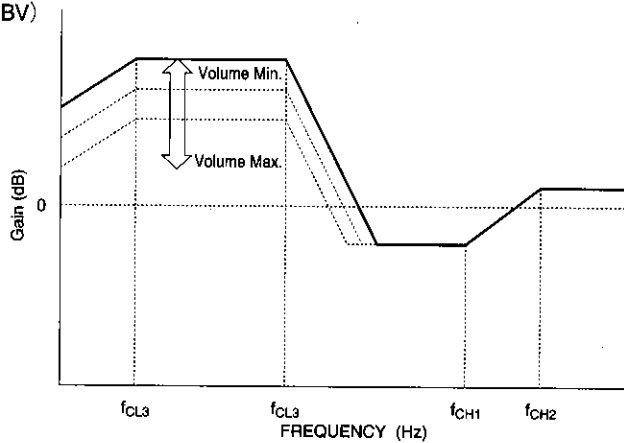
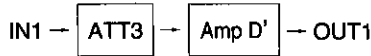

Fig. 8 Characteristics of bass boost control based on the volume

2.2 BBS off

When BBS is off, the signal system is as shown in Fig. 9 due to the switches in the IC, and signal flow is as follows.



The frequency characteristics of each block are shown in Fig. 10, and the gains are given by the following equations :

$$\text{Attenuation of ATT3 : } G_{\text{ATT3}} = 20 \log \frac{R_{20}}{R_{19} + R_{20}} \quad (\text{dB})$$

$$\text{Gain of Amp D' : } G_{\text{D}'} = 20 \log \frac{R_{21} + R_{22}}{R_{21}} \quad (\text{dB})$$

As $R_{19} = R_{20}$ and $R_{21} = R_{22}$, the total gain G_{OFF} when BBS is off is

$$G_{\text{OFF}} = G_{\text{ATT3}} + G_{\text{D}'} \\ = 0 \quad (\text{dB})$$

and the characteristics are flat as shown in Fig. 11.

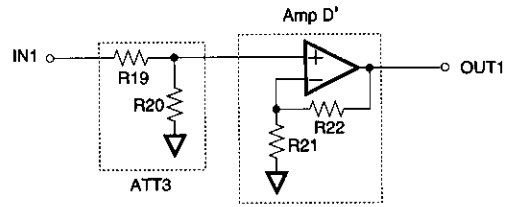

Fig. 9 Signal system when BBS is off

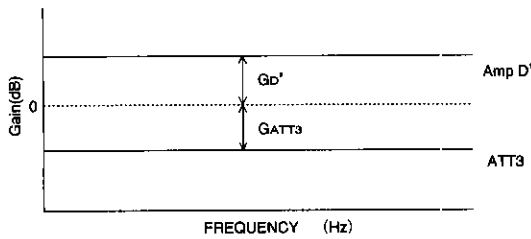

Fig. 10 Frequency characteristics of each block when BBS is off

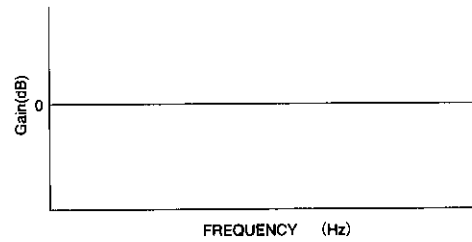
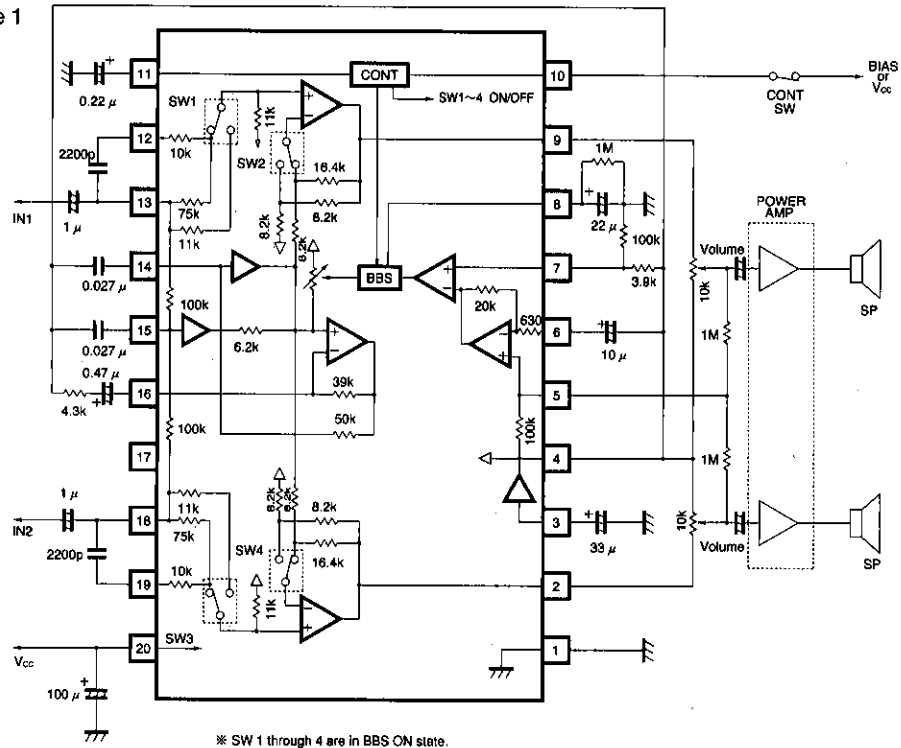
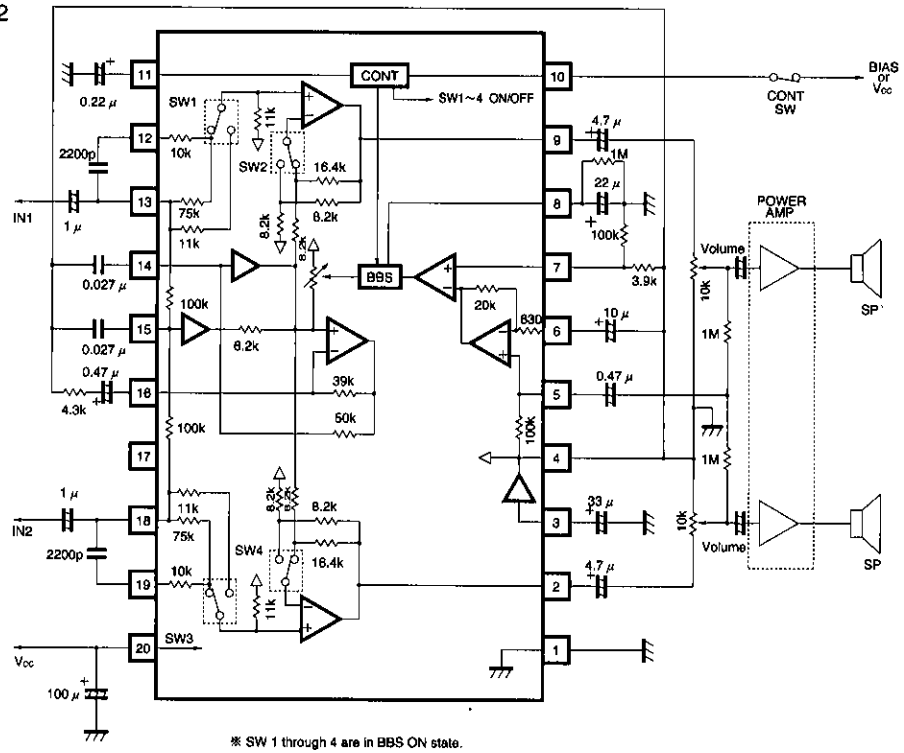

Fig. 11 Total frequency characteristics when BBS is off

● Application example 1



● Application example 2



Audio accessory components Bass boost systems

● Operation notes

1. External value at CONT τ pin

The BBS on / off "pop" sound can be reduced by increasing the value of the capacitor connected to the CONT τ pin, however, on / off switching time will increase. Select a value appropriate for the application.

2. External value at DET NF pin

The gain G_E can be decreased by connecting a series RC circuit to the DET NF pin, however, feedback will increase causing greater susceptibility to oscillation. We recommend a gain G_E of 10dB or more.

3. External value at BBS LEVEL pin

The comparator level can be increased by reducing the ratio of the resistors connected to the BBS LEVEL pin, however, taking into consideration the supply voltage characteristics and transient characteristics, we recommend the following :

$$V_B > V_{BBS\ LEVEL} \geq V_B - 500mV$$

V_B : DC voltage at BIAS OUT pin
(= 1/2 V_{CC})

$V_{BBS\ LEVEL}$: DC voltage at BBS LEVEL pin

4. External value at LP NF pin

The low frequency gain G_B can be decreased by increasing the value of the resistor in the series RC circuit connected to the LP NF pin, however, feedback will increase causing greater susceptibility to oscillation. We recommend a gain G_B of 12dB or more.

5. Coupling capacitors

Decide the polarity of the input and output coupling capacitors based on the electrical potentials of the devices to which they are being connected.

● Measurement data

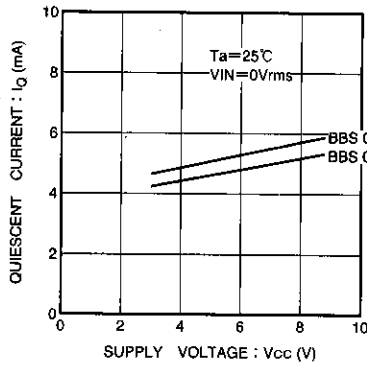

Fig. 12 Quiescent current vs. supply voltage

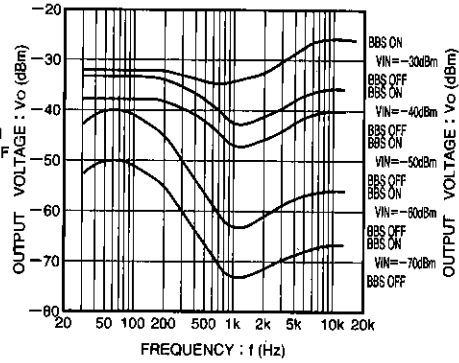

Fig. 13 Output voltage vs. frequency

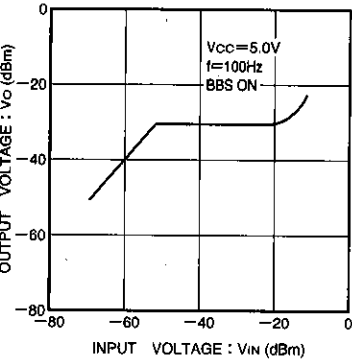

Fig. 14 Output voltage vs. input voltage

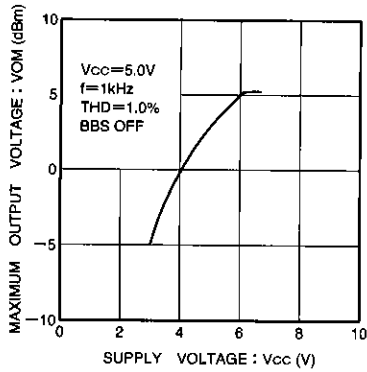

Fig. 15 Maximum output voltage vs. supply voltage

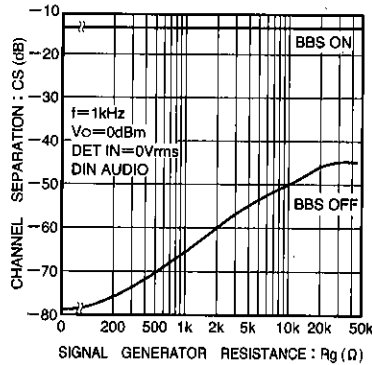

Fig. 16 Channel separation vs. signal generator resistance

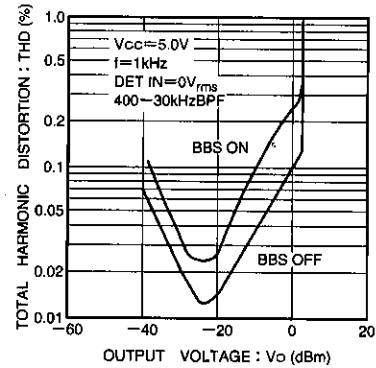

Fig. 17 Total harmonic distortion percentage vs. output voltage

● External dimensions (Unit: mm)

