

Dual ground sense operational amplifier

BA10358/BA10358F/BA10358FV/BA10358N

The BA10358, BA10358F, BA10358FV, and BA10358N are monolithic ICs with two independent built-in operational amplifiers featuring high gain and frequency compensation.

These products offer a particularly wide range of operating voltages, from 3 to 32V (when using a single power supply). Current consumption is low and remains constant regardless of the power supply voltage. Available packages include an 8-pin DIP (BA10358), an 8-pin SOP (BA10358F), an 8-pin SSOP-B (BA10358FV), and an 8-pin SIP (BA10358N).

●Features

- | | |
|--|---|
| <ol style="list-style-type: none"> 1) Can be driven with a single power supply. 2) Extremely low current consumption. 3) Level is compatible with any kind of logic circuit. 4) Operating voltage range is 3 to 32V for single power supply, ± 1.5 to ± 16V for dual power supply. | <ol style="list-style-type: none"> 5) High DC voltage gain. 6) Wide frequency response. 7) Pin layout is the same as the general-purpose 4558 model. 8) Compatible with type 358 operation amplifier. |
|--|---|

●Block diagram

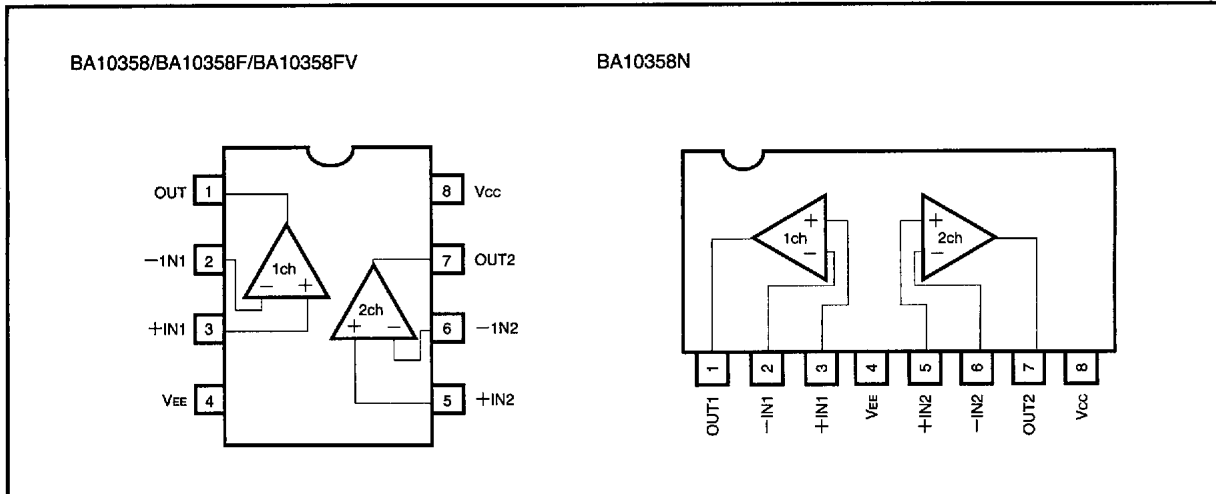

7828999 0021407 0T2

● Internal circuit configuration diagram

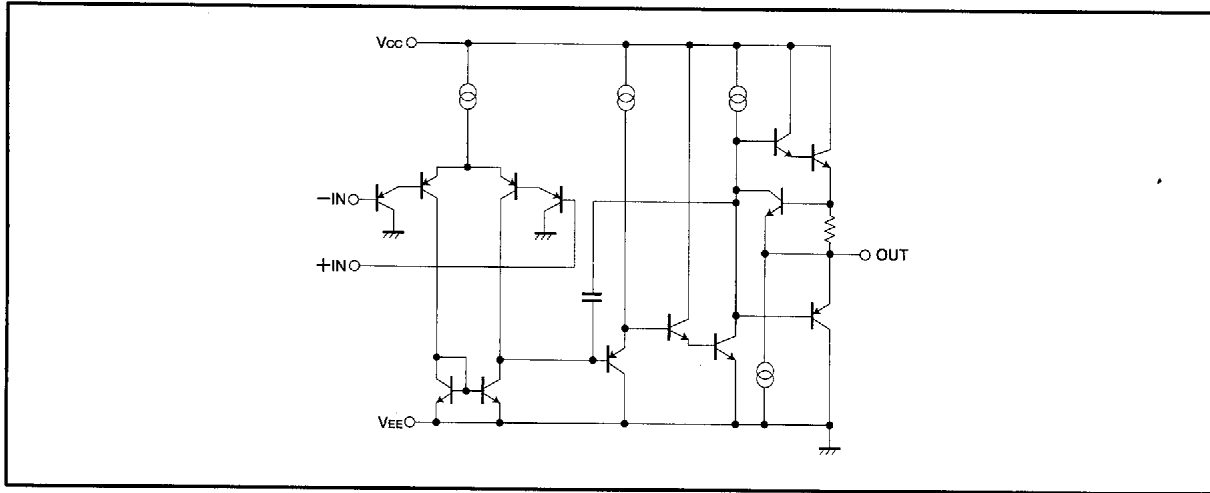

● Absolute maximum ratings

Parameter	Symbol	Limits				Unit
		BA10358	BA10358F	BA10358FV	BA10358N	
Power supply voltage	V _{cc}	32 (±16)	32 (±16)	32 (±16)	32 (±16)	V
Power dissipation	P _d	600*	550*	350*	900*	mW
Differential input voltage	V _{id}	±V _{cc}	±V _{cc}	±V _{cc}	±V _{cc}	V
In-phase input voltage	V _i	-0.3~V _{cc}	-0.3~V _{cc}	-0.3~V _{cc}	-0.3~V _{cc}	V
Operating temperature	T _{opr}	-40~85	-40~85	-40~85	-40~85	°C
Storage temperature	T _{stg}	-55~125	-55~125	-55~125	-55~125	°C

* For P_d values, please see P_d characteristic diagram.

Values are those when BA10358F is mounted on a glass epoxy PCB (50 mm x 50 mm x 1.6 mm).

Values are those when BA10358FV is mounted on a glass epoxy PCB (70 mm x 70 mm x 1.6 mm).

● Electrical characteristics (unless otherwise noted, $T_a=25^\circ\text{C}$, $V_{CC}=+5\text{V}$)

Parameter	Symbol	Min.	Typ.	Max.	Unit	Conditions	
Input offset voltage	V_{IO}	—	2	7	mV	$R_s=50\Omega$	
Input offset current	I_{IO}	—	5	50	nA	—	
Input bias current	I_b	—	45	250	nA	—	
High-amplitude voltage gain	A_v	25	100	—	V / mV	$R_L \geq 2\text{k}\Omega$, $V_{CC}=15\text{V}$	
Common mode input voltage range	V_{ICM}	0	—	$V_{CC}-1.5$	V	—	
Output voltage range	V_O	0	—	$V_{CC}-1.5$	V	$R_L=2\text{k}\Omega$	
Common mode rejection ratio	CMRR	65	80	—	dB	—	
Power supply voltage rejection ratio	PSRR	65	100	—	dB	$R_s=50\Omega$	
Quiescent circuit current	I_Q	—	0.7	1.2	mA	$R_L=\infty$, on All Op - Amps	
Slew rate	S. R.	—	0.2	—	V / μs	$A_v=1$, $R_L \geq 2\text{k}\Omega$	
Maximum frequency	f_r	—	0.5	—	MHz	—	
Channel separation	CS	—	120	—	dB	$f = 1\text{ kHz}$ input conversion	
Maximum output voltage	source	I_{source}	10	20	—	mA	$V_{IN^+}=1\text{V}$, $V_{IN^-}=0\text{V}$, $V_O=0\text{V}$
	sink	I_{sink}	10	20	—	mA	$V_{IN^-}=1\text{V}$, $V_{IN^+}=0\text{V}$, $V_O=V_{CC}$

● Electrical characteristic curves

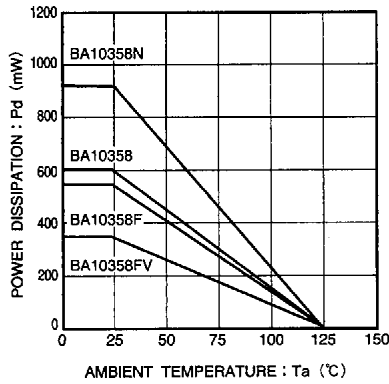

Fig. 1 Power dissipation - ambient temperature characteristic

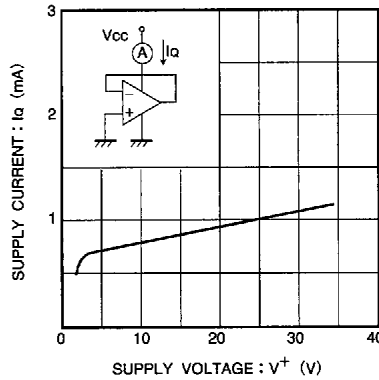

Fig. 2 Quiescent current - power supply voltage characteristic

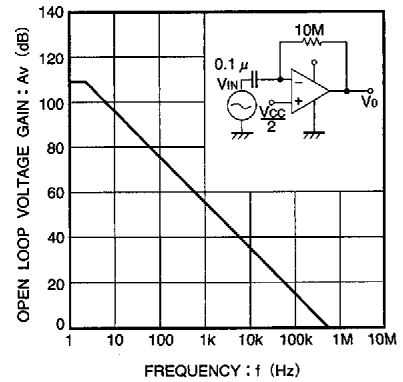

Fig. 3 Open loop voltage gain - frequency characteristic

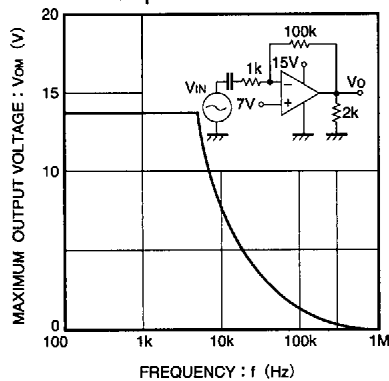

Fig. 4 Maximum output voltage - frequency characteristic

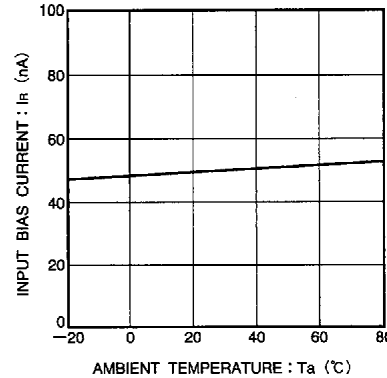

Fig. 5 Input bias current - ambient temperature characteristic

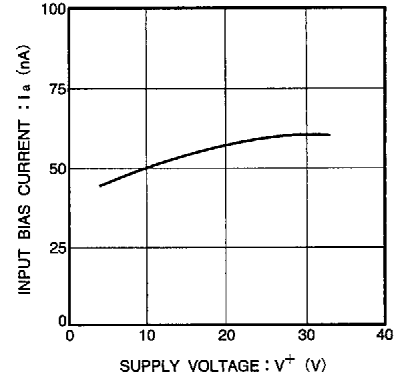

Fig. 6 Input bias current - power supply voltage characteristic

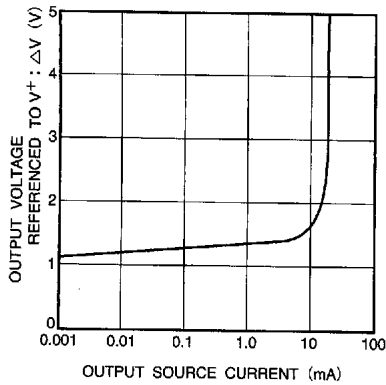

Fig. 7 Voltage difference during power supply output - output source current characteristic

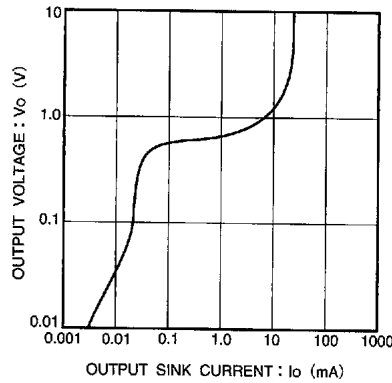

Fig. 8 Output voltage - output sink current characteristic

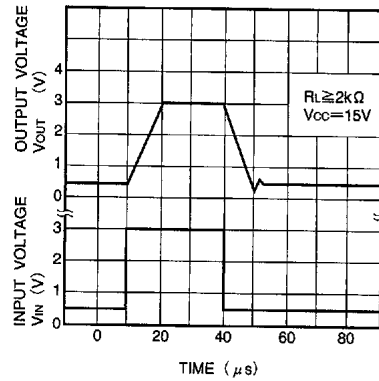

Fig. 9 Output response characteristic

● Operation notes

• Unused circuit connections

If there are any circuits which are not being used, we recommend making connections as shown in Figure 10, with the non-inverted input pin connected to the potential within the in-phase input voltage range (V_{ICM}).

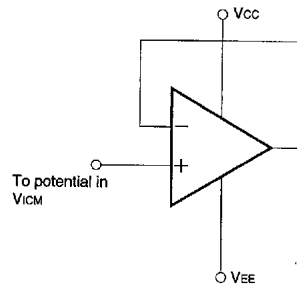

Fig. 10 Unused circuit connections

● External dimensions (Units: mm)

